



*Fitting
Instructions*

Waters

Baths of Ashbourne

Foreword...

Thank you for purchasing a Waters Free-standing bath, It will give you many years of peaceful relaxation, and we hope you don't just have a bath, you Love your bath...



Seb Waters

Prior to installation

Please ensure that your plumbing system is adequate and that you have sufficient space to complete the installation.

Please Note:

We recommend that you employ a suitably qualified plumbing professional to complete the installation of your new bath. We can not accept responsibility for poor or incorrect installation. Please keep these instructions in a safe place for future reference.

Step 1

Unpackaging...

Carefully open the box at the top, cutting the banding and taped seam. Do not insert a blade through the cardboard as this may damage the bath inside.

Remove the top cardboard sheet and corner inserts. Leaving the bath fully wrapped remove from the carton. Carefully unwrap all the shrink wrap and foam protection from around the bath. Remove all packaging from the working area although you may find a cardboard sheet useful as installation template.

Leave the internal cellophane sheet inside the bath until installation is complete to avoid any accidental damage

1,

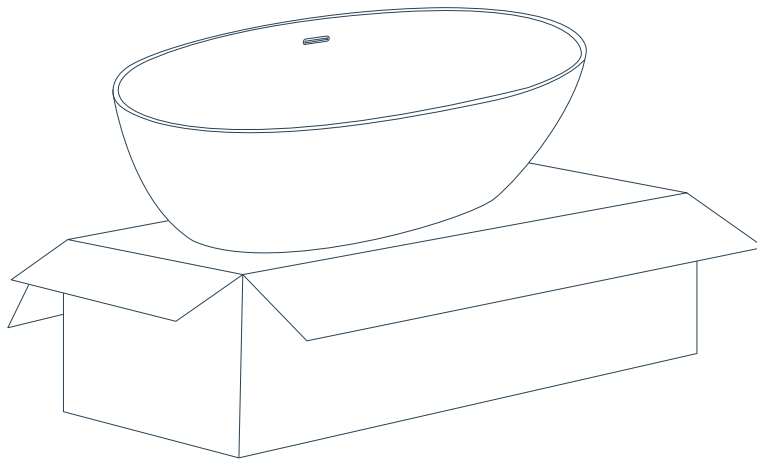

Step 2

Position...

Once unwrapped, carefully check the bath to ensure it is perfect condition before undertaking installation.

For biggest impact we suggest that bath is located a minimum of 150mm away from any wall

Please check you have allowed the correct floor void for your specific bath before installation.

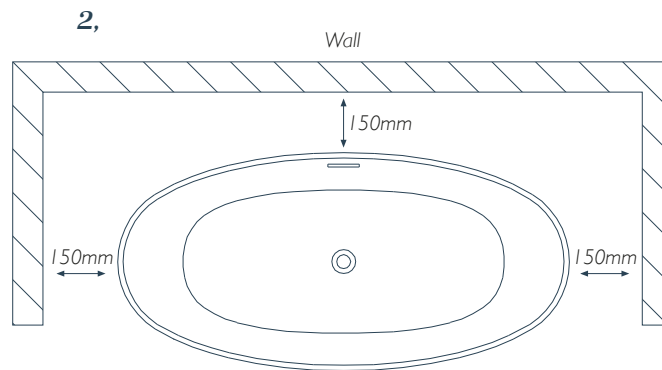

Locate the bath in its intended position and draw around the lower outer edge and mark the waste location with a pencil. Access to the waste and any isolation valves should be considered.

3,

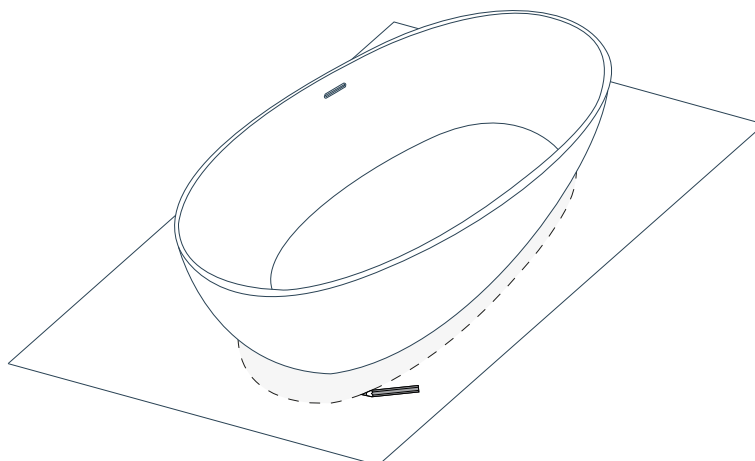

Step 3

Levelling...

With the bath in its intended position use a large spirit level to check that it is level on both the horizontal and vertical planes.

The bath can be adjusted by twisting the four threaded feet. Only if the bath is level will all the water drain to the waste outlet.

Ensure the bath stands evenly at least 1-2mm off the floor to allow for expansion and to create a positive fixing seal.

Once the bath is level, tighten the foot adjustment lock-nuts to ensure no further movement.

Ensure you allow for any variation of the floor surface and that the bath has been levelled in its intended final location.

4,

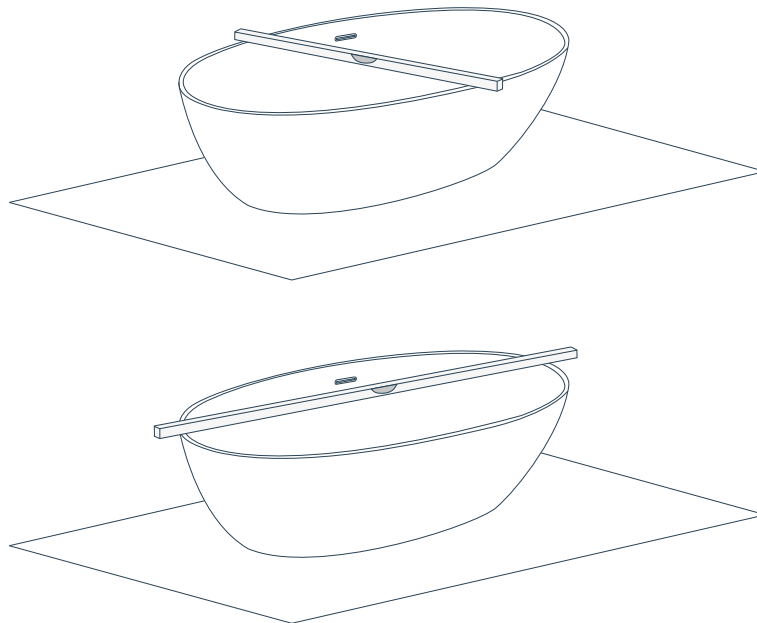

Step 4

Waste...

In most instances the waste will have to be recessed into the floor and connected using a flexible fitting. Once the pipe work is completed and ready to receive the bath we recommend raising the bath on a number of blocks – this will allow working access for you to connect the waste to the underside of the bath.

Once tight add silicone adhesive to the base of each foot, remove the blocks and lower the bath into position, ensuring that the pipe work is not damaged.

5.

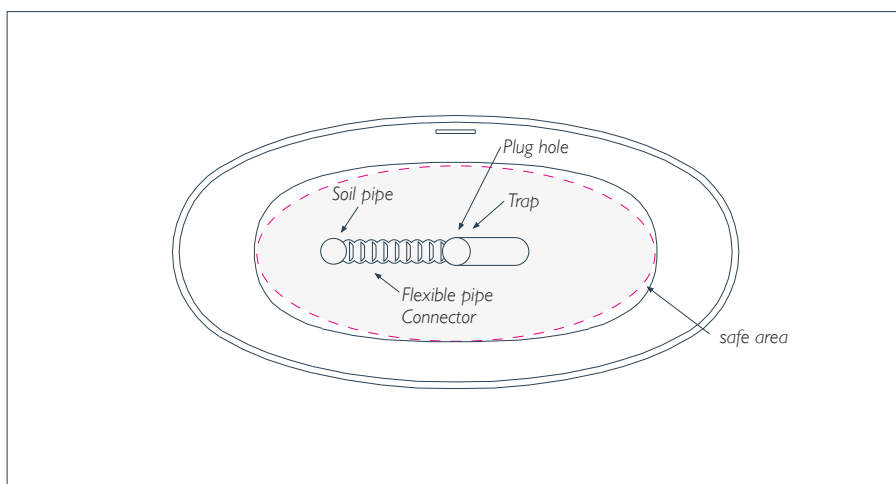
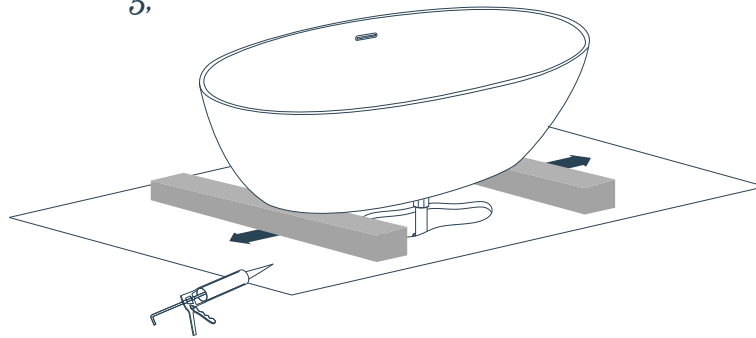

Remember you do not need to fit your bath directly over the soil pipe. It can be positioned anywhere within the shaded area.

Step 5

Fixing...

Before final fixing check that the bath is level and connected to the plumbing system, by adding water and ensuring it drains away adequately leaving no puddles and that there are no leaks.

Once checked, half fill the bath to ballast it before securing it to the floor.

Apply silicone adhesive evenly between the base of the bath and the floor filling the 1-2mm gap.

To ensure the best result leave the water in the bath 10 – 12 hours or overnight while the silicone adhesive sets.

6,

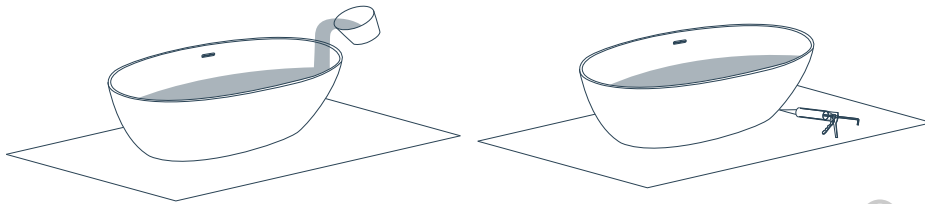

10-12 Hours

Care Info

To clean your bath use a soft damp cloth and warm soapy water, household bathroom cleaners may also be used – but you should check their suitability before proceeding.

Do not use abrasive scrubbing materials or harsh chemical cleaners as these may permanently damage the bath's surface and finish.

Warning

Solvents such as paint stripper or nail varnish remover will damage the bath.

Warranty

& Guarantees

To demonstrate our confidence in the quality and reliability our products, all Waters Baths of Ashbourne Baths are guaranteed to be free of defects in material and workmanship during use by the original purchaser for a period of 20 years and bespoke paint finishes 2 years from date of purchase.

Subject to the terms contained herein, Waters Baths will, at its discretion, repair or replace any defective product, or refund the purchase price. In no event shall the liability under this warranty exceed the original purchase price of the product. Waste kits and accessories are not covered under this guarantee.

Exceptions.

The guarantee does not extend to:

- *Damage caused by cleaning, maintenance, or installation performed other than strictly in accordance with the information contained in the fitting Instructions;*
- *Damage caused by the use of strong chemicals in cleaning;*
- *Damage caused by the use of strong dyes or colourants*
- *Scratching, or staining of the finish over time due to water impurities or atmospheric conditions;*
- *Damage caused by extreme temperature conditions;*
- *Damage due to installation error, product neglect, misuse, or abuse, accident, or negligence, whether caused by the purchaser, a contractor, or a service provider, or any other cause beyond the sellers control.*

Replacement.

Waters Baths of Ashbourne will replace or repair the installed defective products subject to the following conditions:

- *Any claim is made in writing to our office within 10 days of the problem being apparent;*
- *Any claim is by the original purchaser, this guarantee is not transferable;*
- *The product has been used in the manner that it was intended, this protection does not apply to any products that have been misused in any way;*
- *The product must have been installed and cared for in line with our Installation and care instructions.*

(See Installation and care Instructions for proper cleaning, maintenance, and installation information.)

Making a Claim.

To file a claim, contact Waters Baths of Ashbourne through your supplying retailer or by writing to us at Waters Baths of Ashbourne, Long Lane, Dalbury Lees, Ashbourne, Derbyshire, DE6 5BG. Please be sure to provide all relevant information along with supporting images regarding your claim, including a complete description of the problem, the model name, size and any bespoke finish applied to the product, along with the date and place of purchase. Also include your original invoice. In order to assess any claim, we may have to inspect the product as installed before removal and must be provided with access to the product upon request.

Except as provided herein, seller makes no guarantee of any kind, express or implied, with respect to the product, its merchantability, or fitness for a particular purpose. Seller shall not be responsible for any indirect, incidental, or consequential damages resulting from the delivery, installation, or use of the product.

Before installing the bath please read our installation and care instructions. If you have any questions please contact your supplying dealer or us directly on +44 (0) 1332 824166 or via email on info@watersbaths.co.uk

Tech Info

Bath Specification...

i-Line collection...

If you desire the most slender slim-line design, our i-Line range has the bath to excite your senses. Waters Baths of Ashbourne are proud to have combined our expert craftsmanship with the very latest techniques and materials to create a collection of 20mm edged acrylic baths.

Stream

1540mm - 1700mm



Sizes available:

1540 x 750 x 580mm
1700 x 820 x 580mm
- LxWxH

Weights:

1540mm - Gross 55kg - Net 45kg
1700mm - Gross 63kg - Net 51kg

Fill information: 1540 1700

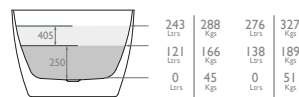

Filler options:

FSBF, WF, BF, CF.

Please note:

Minimum installation void required for trap and waste is 15mm below floor level.

Spa

1540mm - 1670mm



Sizes available:

1540 x 750 x 660mm
1670 x 790 x 660mm
- LxWxH

Weights:

1540mm - Gross 54kg - Net 44kg
1670mm - Gross 55kg - Net 45kg

Fill information: 1540 1670

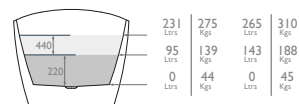

Filler options:

FSBF, WF, BF, CF.

Please note:

Minimum installation void required for trap and waste is 5mm below floor level.

Loche

1660mm



Sizes available:

1660 x 800 x 565mm
- LxWxH

Weights:

1660mm - Gross 55kg - Net 45kg

Fill information: 1660

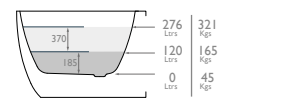

Filler options:

OWF, WF, BF, CF.

Please note:

Minimum installation void required for trap and waste is 5mm below floor level.

Pool

1500mm - 1600mm



Sizes available:

1500 x 750 x 580mm
1600 x 800 x 580mm
- LxWxH

Weights:

1500mm - Gross 56kg - Net 45kg
1600mm - Gross 60kg - Net 49kg

Fill information: 1500 1600

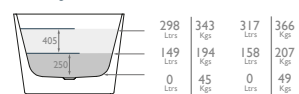

Filler options:

FSBF, WF, BF, CF.

Please note:

Minimum installation void required for trap and waste is 20mm below floor level.

Cove

1700mm



Sizes available:

1700 x 800 x 580mm
- LxWxH

Weights:

1700mm - Gross 60kg - Net 51kg

Fill information: 1700

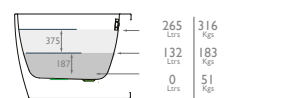

Filler options:

OWF, WF, BF, CF.

Please note:

Minimum installation void required for trap and waste is 0mm below floor level.

Strait

1660mm



Sizes available:

1660 x 800 x 580mm
- LxWxH

Weights:

1660mm - Gross 62kg - Net 55kg

Fill information: 1660

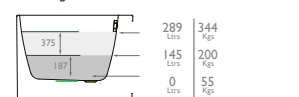

Filler options:

OWF, WF, BF, CF.

Please note:

Minimum installation void required for trap and waste is 0mm below floor level.

Wave²

1670mm



Sizes available:

1670 x 800 x 850mm
- LxWxH

Weights:

1670mm - Gross 57kg - Net 48kg

Fill information: 1670

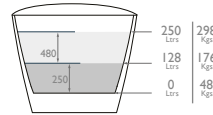

Filler options:

FSBF, WF, BF, CF.

Please note:

Minimum installation void required for trap and waste is 0mm below floor level.

River

1600mm



Sizes available:

1600 x 750 x 580mm
- LxWxH

Weights:

1600mm - Gross 60kg - Net 53kg

Fill information: 1600

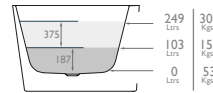

Filler options:

OWF, FSBF, WF, BF, CF.

Please note:

Minimum installation void required for trap and waste is 0mm below floor level.

Fjord

1700mm



Sizes available:

1700 x 800 x 580mm
- LxWxH

Weights:

1700mm - Gross 52kg - Net 42kg

Fill information: 1700

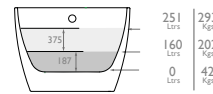

Filler options:

OWF, FSBF, WF, BF, CF.

Please note:

Minimum installation void required for trap and waste is 0mm below floor level.

Brook²

1500mm - 1660mm



Sizes available:

1500 x 820 x 580mm
1660 x 820 x 580mm
- LxWxH

Weights:

1500mm - Gross 48kg - Net 42kg
1660mm - Gross 55kg - Net 47kg

Fill information: 1500 1660

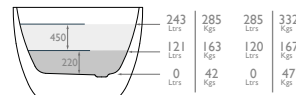

Filler options:

FSBF, WF, BF, CF.

Please note:

Minimum installation void required for trap and waste is 0mm below floor level.

Lake²

1600mm



Sizes available:

1660 x 800 x 580mm
- LxWxH

Weights:

1660mm - Gross 68kg - Net 60kg

Fill information: 1660

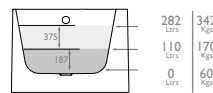

Filler options:

OWF, FSBF, WF, BF, CF.

Please note:

Minimum installation void required for trap and waste is 0mm below floor level.

Spring

1740mm



Sizes available:

1740 x 820 x 580mm
- LxWxH

Weights:

1740mm - Gross 59kg - Net 50kg

Fill information: 1740

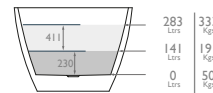

Filler options:

FSBF, WF, BF, CF.

Please note:

Minimum installation void required for trap and waste is 0mm below floor level.

Full specs available from our website: www.watersbaths.co.uk

Filler option key: FSBF - Freestanding bath filler, OWF - Overflow waste filler, WF - Wall filler, BF - Bottom filler, CF - Ceiling filler

NB: As our baths are individually hand made, dimensions may vary +/- 5mm & upon close inspection a fine joint line maybe seen due to the two part construction. Our GOES WELL WITH recommendations are suggestions of third party products that complement our baths. They are not an endorsement of our products by any manufacturer or brand. Product and brand names are copyright of the identified manufacturers. Other brands are available.

Linear collection...

Created to meet the demands of the most discerning customers, our Linear range features a choice of styles to suit varied yet always impeccable tastes. Whether you prefer seamless curves or something more angular, you'll find a bath that fits the most modern or traditional of bathrooms.

Willow

1690mm



Sizes available:

1690 x 800 x 580mm
- LxWxH

Weights:

1690mm - Gross 50kg - Net 46kg

Fill information: 1690

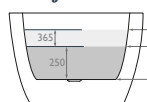

238 Ltrs	284 Kgs
119 Ltrs	165 Kgs
0 Ltrs	46 Kgs

Filler options:

OWF, FSBF, WF, BF, CF.

Please note:

Minimum installation void required for trap and waste is 15mm below floor level.

Bracken

1670mm



Sizes available:

1670 x 800 x 555mm
- LxWxH

Weights:

1670mm - Gross 54kg - Net 48kg

Fill information: 1670

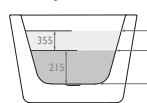

221 Ltrs	269 Kgs
111 Ltrs	159 Kgs
0 Ltrs	48 Kgs

Filler options:

OWF, FSBF, WF, BF, CF.

Please note:

Minimum installation void required for trap and waste is 5mm below floor level.

Marsh

1500mm - 1715mm
1800mm



Sizes available:

1500 x 783 x 580mm
1715 x 783 x 560mm
1800 x 783 x 540mm
- LxWxH

Weights:

1500mm - Gross 48kg - Net 42kg
1715mm - Gross 54kg - Net 46kg
1800mm - Gross 59kg - Net 50kg

Fill information: 1500 1715 1800

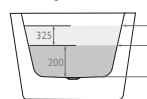

204 Ltrs	244 Kgs	222 Ltrs	268 Kgs	238 Ltrs	288 Kgs
103 Ltrs	145 Kgs	111 Ltrs	157 Kgs	128 Ltrs	178 Kgs
0 Ltrs	42 Kgs	0 Ltrs	46 Kgs	0 Ltrs	50 Kgs

Filler options:

OWF, FSBF, WF, BF, CF.

Please note:

Minimum installation void required for trap and waste is 15mm below floor level.

Full specs available from our website: www.watersbaths.co.uk

W
a

www.watersbaths.co.uk

Lawns Farm, Long Lane, Dalbury Lees, Ashbourne, Derbyshire, DE6 5BG.
t: 01332 824166 - e: info@watersbaths.co.uk