

Bolton 1805

L 1805 x W 860 x H 600 mm

Royce Morgan

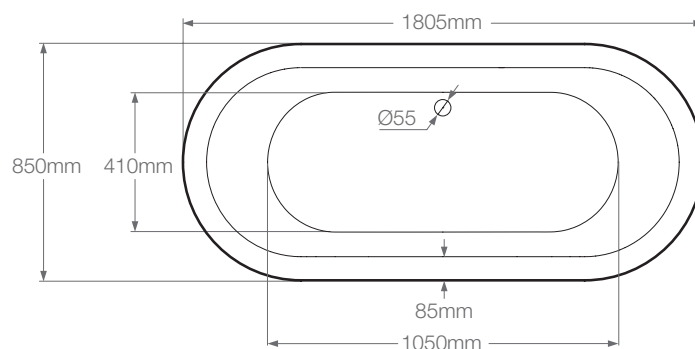
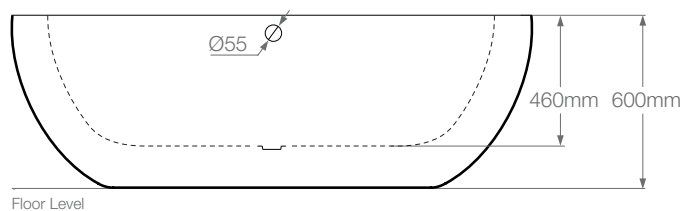

General Specification

Litres to overflow: 215 litres

Weight: 48kg

Weight (with water): 263kg

Tap Holes: No tap holes, suitable for freestanding or wall mounted taps

Lifetime Guarantee (*Terms & Conditions apply*)

Recommended Waste

W4: Concealed Chain Waste

W5: Concealed Pop-up Waste

W13: Concealed Click Clack Waste

Accessories

W11: Over Edge Chrome Pipe Shrouds

W14: Over Edge Chrome Pipe Shrouds
(with Handle for Bath Shower Mixer)

W15: 40mm Flexible Waste Pipe

Please Note: This is a two piece handcrafted bath, there may be a visible line on close inspection.

Please Note: We strongly recommend that you use a suitably qualified installer. We cannot accept responsibility for incorrect installation.
RM2012 - N.B Dimensions may vary due to the handmade construction of the baths.

www.roycemorgan.co.uk