

Technical Data Sheet

ROPER RHODES®

SCHEME 600mm WALL MOUNTED UNIT

Whats in the box: 1x SCH600.X + Fixings

*Reference basin TDS for further info

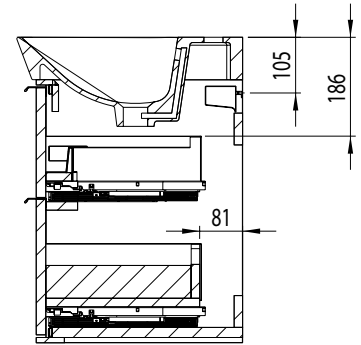
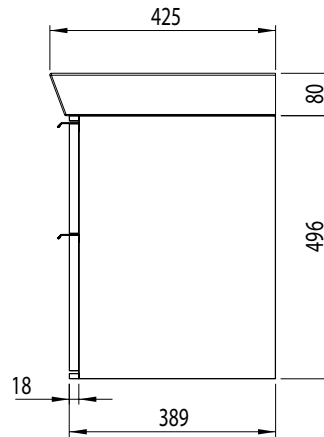
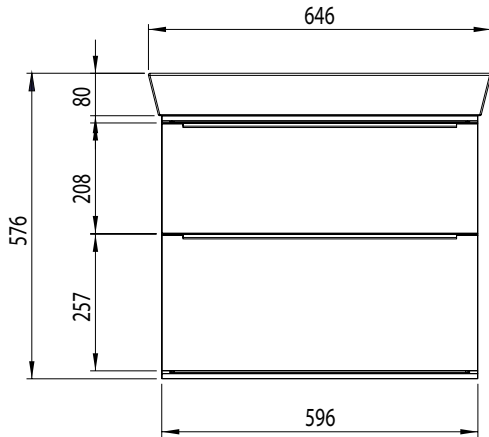

Diagrams not to scale
All dimensions in mm
tolerance of +5mm

Materials

Carcass: 16mm MDF and MFC
Fascia Components: 18mm MDF

**Dimensions are subject to change, customers are advised to measure actual product before commencing installation.
***Fixing point dimensions are for guidance only/the positions of wall fixing must be checked when product is received.

Extra Dimensions

Internal Drawer Depth - Front to Back:	274mm
Internal Drawer Height:	69mm
Internal Drawer Width:	482mm
Drawer Cut Out (W&D):	184mm wide& 249mm Depth
Hanger Centres:	549mm

FAQs

Q: How big is the plumbing void at the back of the furniture?	A: 81mm
Q: How far apart are the hole centres for the handles?	A: 288mm (comes with template)
Q: Are the handles fitted?	A: No, holes centres need drilling for handle fitting.
Q: Are the runners soft close?	A: The runners are both soft close and quick release.
Q: How deep is the unit when the drawers are fully open?	A: Approx. 700mm including handle.
Q: Can the drawers be adjusted?	A: Yes, vertical and horizontal.
Q: What is the interior finish of the unit?	A: The unit interior is the same finish as the exterior.

NOTE: Colours unique to Roper Rhodes - No RAL Code available