

Technical Specification Sheet

MONACO 15
S/S 1.5 Bowl with Drainer
R37973 / 2144S

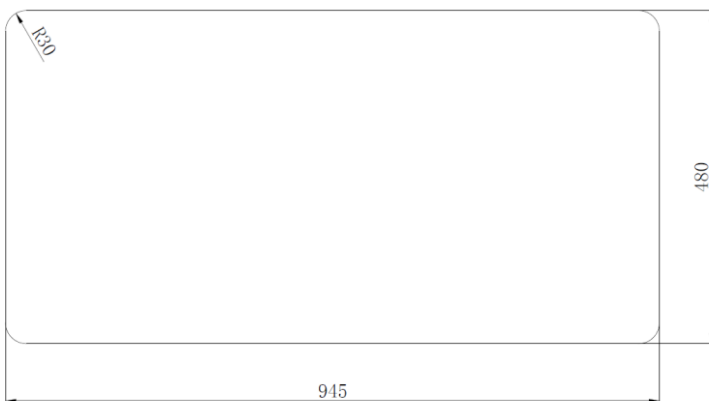
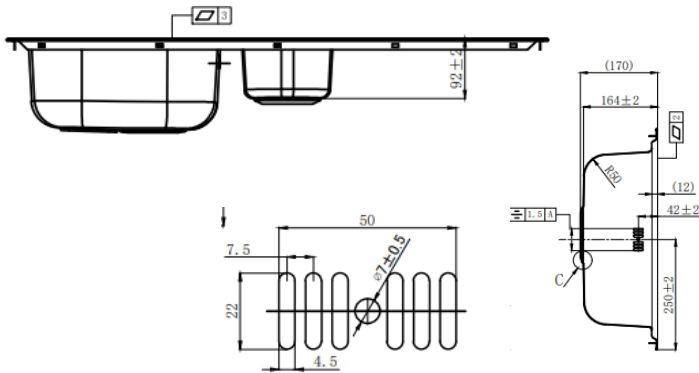
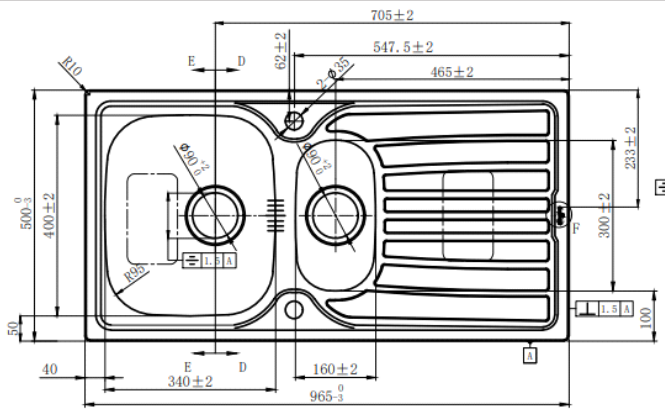

Specification

Material	Stainless Steel
Finish	Polished
Colour	Stainless Steel
Gauge	0.7
Welded/Pressed	Pressed
No. of bowls	2
Fitting Method	Inset
Handing Options	Reversible
Cabinet Size (mm)	600
Overall Length (mm)	965
Overall Width (mm)	500
Overall Depth (mm)	170
Main Bowl Length (mm)	340
Main Bowl Width (mm)	400
Main Bowl Depth (mm)	164
Second Bowl Length (mm)	160
Second Bowl Width (mm)	300
Second Bowl Depth (mm)	92
Tap Hole Size (mm)	35
Waste Kit Included (Yes/No)	Yes
Clips & Seals Included (Yes/No)	Yes
Waste Size (mm)	90
Waste Kit Code	M 3079
Clips & Seals Code	N/A
Overflow Location	Main Bowl
Cut Out Length (mm)	945
Cut Out Width (mm)	480
Product Weight (kg)	3.2
Packed Weight (kg)	4.6
Packed Dimensions (mm)	1010x545x185mm
EAN number	8712465037973

Warranty

Lifetime on manufacturing | 1 years serviceable parts warranty (waste kit, clips & seals)

Care & Maintenance

Clean with warm soapy water only | You can use the Reginox INOX care cream to help maintain the steel finish | Avoid using anything abrasive on sink surface as will void the warranty