

RS DSM C

RENAISSANCE Tap Range

Renaissance Deck Sink Mixer Chrome



Features:

- Long life and easy to use 1/4 turn ceramic disc valves
- Metal handles
- Dual flow prevents hot water entering the mains supply
- Chrome plated to BS EN 248

Product Certifications:



For more products, visit our website:
<http://www.bristan.com>



Specification

Product Type:	Taps
Main Construction Material:	Brass
Mount Type:	Deck Mounted
Handle Type:	Lever Handles
Connection Inlet:	1/2" BSP
Connection Outlet:	Anti-Splash
Number of Tap Holes:	2
Valve/Cartridge Type:	1/4 Turn Ceramic Disc
Plumbing System Requirements:	Suitable for all plumbing systems
Minimum Dynamic Pressure (bar):	0.2 bar
Maximum Dynamic Pressure (bar):	5.0 bar
Maximum Hot Water Temperature °C:	65°C
Maximum Static Pressure (bar):	10 bar
Flow Type:	Dual Flow
Isolation Included:	No

Dimensions (measurements in mm)

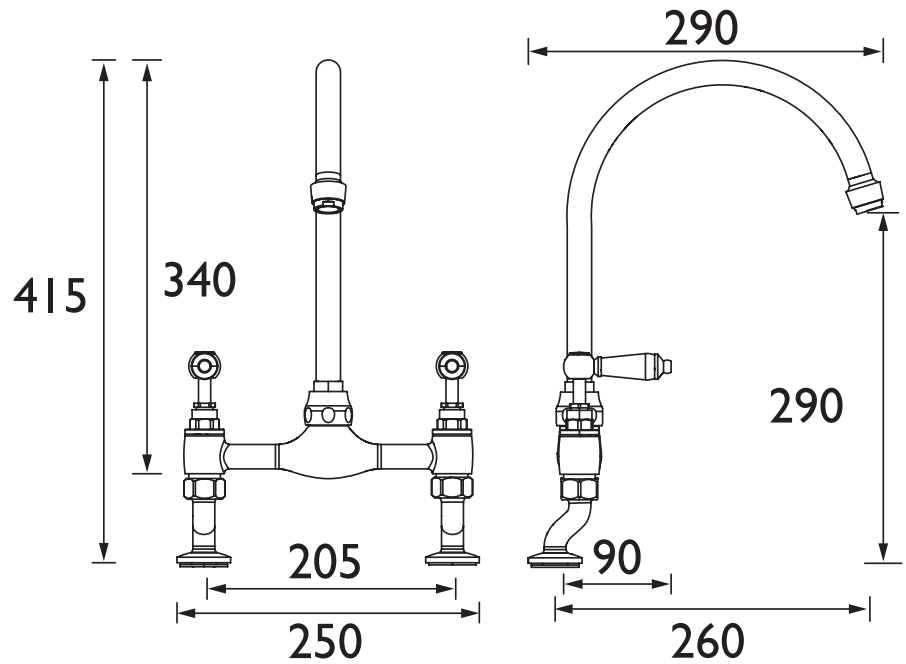

Flow Rates (l/min)

System Pressure (bar)	0.2	0.5	1	2	3	5
RS DSM C (mixed)	14	22.2	31.4	44.4	54.4	70.2

TECHNICAL DATA SHEET



BRISTAN

D14