

R2 SHXRR C

REGENCY Shower Range

Regency2 Thermostatic Surface Mounted Dual Control Shower Valve with Rigid Riser Chrome



Features:

- 15mm inlet connections
- Easy replacement with adjustable inlets so you can use on existing pipework centres between 110mm and 155mm
- Thermostatic cartridge with preset temperature stop at 42°C
- TMV2 thermostatic control for a higher level of performance and protection
- Supplied with 1 x 7L/min and 1 x 5L/min flow regulators

Product Certifications:

WRAS Certificate No: 1904904
WRAS Expiry Date: 30/04/2024



TMV2 Cert. No: NSF2124/0619
TMV2 Expiry Date: 13/06/2024



Specification

Finish/Colour:	Chrome Plated
Main Construction Material:	Brass
No of Controls:	2
Shower Type:	Thermostatic
Shower Head Type:	Fixed Head
Shower Kit:	Rigid Riser
Valve/Cartridge Type:	Thermostatic
Maximum Hot Water Supply Temperature °C:	65
Plumbing System Suitability:	Suitable for all plumbing systems
Minimum Dynamic Pressure (bar):	0.1
Maximum Dynamic Pressure (bar):	5
Maximum Static Pressure (bar):	10
Connection Inlet:	15mm Compression Elbows
Connection Outlet:	G 1/2"
Isolation Valve Included:	No
Check Valve Included:	Yes

Dimensions (measurements in mm)

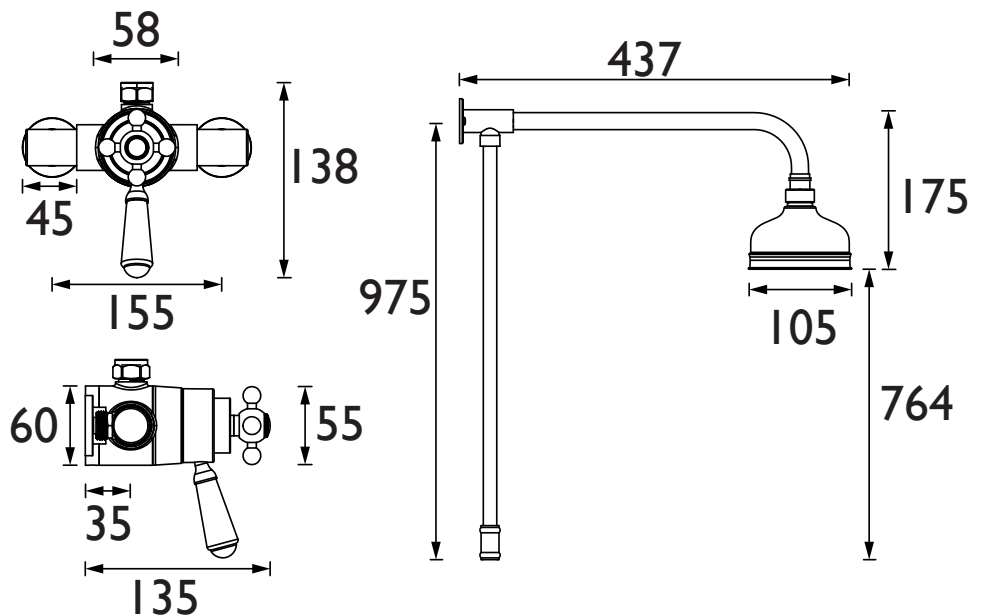

Flow Rates (l/min)

System Pressure (bar)	0.1	0.5	1	2	3	5
Valve Only (mixed)	5.6	12.5	17.7	25	30.6	39.5
Through Fixed Head (mixed)	2.4	5.4	7.6	10.8	13.2	17

TECHNICAL
DATA
SHEET



BRISTAN

D7