

BUILT-IN CERAMIC HOB

INSTALLATION AND OPERATION MANUAL

PRCEH104
PRCEH106

Please read the instruction manual carefully before operating your new hob.

Dear Owner: Thank you for purchasing our cooktop which is designed to give you many years of cooking pleasure. Before using your new appliance please read the user's manual carefully and keep it in a safe place for future reference.

THIS APPLIANCE MUST BE INSTALLED ONLY BY A QUALIFIED PERSON IN INSTRUCTIONS PROVIDED. THE MANUFACTURER DECLINE ALL RESPONSIBILITY FOR IMPROPER INSTALLATION WHICH MAY HARM PERSONS AND ANIMALS OR CAUSE DAMAGE TO PROPERTY. THE APPLIANCE MUST BE USED ONLY FOR THE PURPOSE FOR WHICH IT WAS EXPRESSLY DESIGNED. ANY OTHER USE (e.g. HEATING ROOMS) IS CONSIDERED TO BE IMPROPER AND MANUFACTURER DECLINES ALL RESPONSIBILITY FOR DAMAGE RESULTING FROM IMPROPER AND IRRESPONSIBLE USE.

Cod: 0070303280

Use

Directions and suggestions for using

- Do not touch the built-in ceramic hob with wet hands or feet.
- Do not operate the built-in ceramic hob when you are barefoot.
- Do not let young children operate the built-in ceramic hob.
- Please disconnect the power supply before you do any maintenance and cleaning.
- When the built-in ceramic hob is working, the temperature of the hob and the ambient temperature become higher, so please do not touch it and keep the children away from it.
- A steam cleaner must not be used for cleaning the appliance.
- The appliance is not intended to be operated by means of an external timer or separate remote-control system.
- The built-in ceramic hob must be built into a heat resistant cabinet. Some smoking may occur when first used. Leave on for a short period to burn off excess sealant.

Operation of the top with the heating area

An appropriately selected pan saves energy. A pan should have a thick, flat base with a diameter equal to the plate diameter as in that case heat is transferred most efficiently.

Advice on the use of cooking tops. To save energy and to prolong the life of the ceramic tops, we advise using pans with flat bottom and with a diameter no less than the diameter of the tops. Care must be taken that fluids do not spill on the ceramic plates. Never leave the tops on without pans on them or with empty pans and never use the tops to heat plates. Switch on the elements after having set the pans on them. Once switched off, the elements remain warm for a while, do not touch. Switch off the heating element before removing the pans.

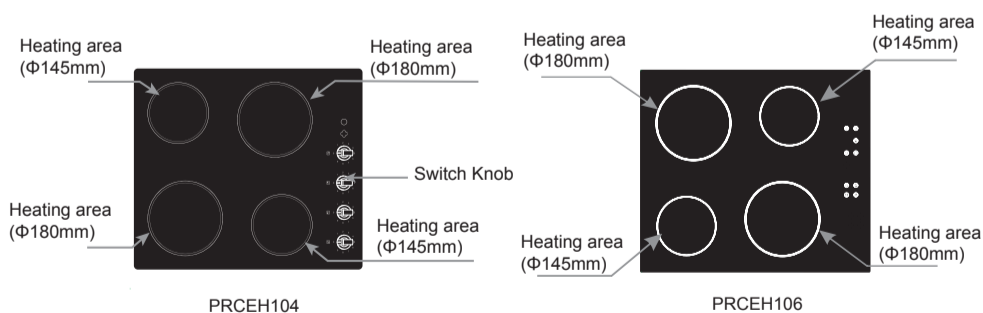

Touch control For PRCEH106

- All operations are performed by means of the touch controls on the control panel.
- Each touch control has a corresponding visual display (indicator light).
- You will hear a beep each time a touch is registered.

Switching on the ceramic hob

- Press the ON/OFF button (fig. 1) to switch on the appliance.
- The hob will beep once and all cooking zone indicators will light up briefly, indicating that the hob has entered stand-by mode.

Notice: Take the next step within one minute, otherwise the controller will automatically shut down.

Switching on a cooking zone and setting a power level

- Press the cooking zone select button (fig. 2) for the zone you want to use.
- Select the heat level required (1-9) by using the up and down buttons (fig. 3). By holding down either of these buttons, the value on the heat level display will adjust up or down.

Note: when the power displayed 0, press the down button, the power will set to 9.

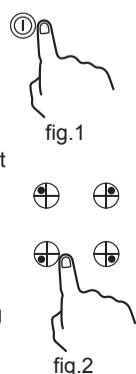

SAFETY WARNING

- Please check the built-in ceramic hob's integrity after opening the package. If there are any problems please refer to the supplier.
- Do not throw the package materials (plastic bag, foam, nails, package etc) in a place where children can easily access. Please dispose of packaging in an environmentally friendly manner.
- Do not change the wiring under any circumstances.
- Dispose of the appliance in an environmentally friendly manner.
- If the supply cord is damaged, it must be replaced by the manufacturer its service agent or similarly qualified persons in order to avoid a hazard.
- Children and persons with reduced physical, sensory or mental capabilities or lack of experience and knowledge should be supervised to ensure appliance is used safely.
- Children should be supervised to ensure that they do not play with the appliance. Cleaning and user maintenance shall not be made by children without supervision.
- Do not stare at the hob elements when the appliance is working.
- Accessible parts may become hot during use. To avoid burns young children should be kept away
- WARNING:** If the surface is cracked, switch off the appliance to avoid the possibility of electric shock, for hob surfaces of glass-ceramic or similar material which protect live parts
- Shall state a steam cleaner is not be used.
- Metallic objects such as knives, forks, spoons and lids should not be placed on the hob surface since they can get hot.
- CAUTION:** The surface temperature exceeds 95°C. To avoid a hazard, under bench access must be restricted. Refer to the installation instructions.
- WARNING:** The appliance and its accessible parts become hot during use. Care should be taken to avoid touching heating elements. Children shall be kept away unless continuously supervised.
- The appliance is not intended to be operated by means of an external timer or separate remote-control system.
- WARNING:** Unattended cooking on a hob with fat or oil can be dangerous and may result in fire. NEVER try to extinguish a fire with water, but switch off the appliance and then cover flame e.g. with a lid or a fire blanket.
- WARNING:** Danger of fire: do not store items on the cooking surfaces.
- CAUTION:** The cooking process has to be supervised. A short term cooking process has to be supervised continuously.
- WARNING:** Use only hob guards designed by the manufacturer of the cooking appliance or indicated by the manufacturer of the appliance in the instructions for use as suitable or hob guards incorporated in the appliance. The use of inappropriate guards can cause accidents.

A duplicate data label and wiring diagram are contained in this booklet. Please attach these labels to an accessible and near by surface for easy reference. The Manufacturer shall not be held responsible for any inaccuracies in this handbook due to printing or transcription errors, also the designs in the figures are purely indicative. The Manufacturer also reserves the right to make any modifications to the products as may be considered necessary or useful also in the interests of the user, without jeopardizing the main functional and safety features of the products themselves.

Switching off the ceramic hob

- Press the ON/OFF button, the hob will switch off. It is possible to turn the hob off at any time by pressing the ON/OFF button.
- Press the up or down buttons to 0, then hob will switch off.

After a zone is switched off, the corresponding heat level display will show a flashing letter "H". This means that the temperature of the zone is above 60°C and is therefore still high enough to cause injury.

- When the temperature of the zone falls below 60°C the letter "H" will go out. It is still possible to burn yourself on a hob zone, even when its temperature has dropped below 60°C.

IMPORTANT: The residual heat indicator will disappear if the mains supply to the product is cut.

Locking the ceramic hob

To lock the ceramic hob, press the safety lock button (fig. 4) while the appliance is switched on. With the safety lock activated, all buttons on the control panel will be disabled, except the ON/OFF button. To disable the safety lock feature, press the safety lock button again. You are then able to adjust the heat level of any zone on the hob.

Timer

If touch-controlled, your hob has a timer which you can set (from 1 to 99 minutes) for each cooking zone. At the end of the countdown period, a buzzer will sound and the relevant cooking zone will be switched off.

- Select the cooking zone (fig. 2) and heat level (fig. 3).
- Press the timer button (fig. 5), and then use the up and down buttons to set the countdown time.
- Each time the timer up/down button is pressed, the timer display will increase or decrease in 1 minute increments.

Safety cut-off

- If one or more of the cooking zones are accidentally left on, a safety cut-off will activate after a certain period of time. The length of time depends on the set power level for that zone. The table on the right gives the time limits for each power level.
- If more than one zone is operating when one of the zones reaches its safety cut-off point, only the zone that has reached its safety cut-off point will switch off.

Power level	Time limit (hours)
1-2	6
3-4	5
5	4
6-9	1.5

For PRCEH104, according to your needs, the tops can be adjusted by turning the knobs either clockwise or anti-clockwise to 9 positions besides the 0 position (off). The positions marked by the higher numerical index match the maximum output of heat (see table).

When using rapid tops, a thermostat automatically reduces the power when the selected temperature is reached and the top operates intermittently to reach a constant cooking temperature. The pilot light set in the control is a signal that the electric elements are switched on. The level of heat can be adjusted gradually by turning the appropriate knob to the right or left. Switching on the element results in an orange signal light illuminating on the control panel.

0	Switch off
1-2	MIN. Warming up
3-4	Stewing vegetables, Slow cooking
5-6	Slow frying
7-8	Grilling meat, fish
9	MAX. Fast heating up, Fast cooking, Frying

Technical Data

Model	Power Supply	Power(W)		Size (mm) ex knobs (104)	Built-in Hole Size (mm)
PRCEH104	AC220-240V 50Hz	1200W (145mm)	1800W(180mm)	580X510X52	560(L)X490(W)
PRCEH106		1200W (145mm)	1800W(180mm)	580X510X52	560(L)X490(W)

Utensils

Use pans with flat bottoms. Uneven or thin bottoms will waste energy and are slow to cook. Use pans slightly larger than the hotplates. Smaller pans will waste energy. Do not use oversized pans. More than 50mm overhang can overheat cooktop components and can cause fine cracks in the enamel hob which will trap dirt. Use only dry utensils. Do not place wet or steamy parts (eg.lids) on the hotplates.

Use

Do not use pots and pans that are unsteady and likely to rock or overbalance. Do not operate the cooktop for an extended time without utensil on the hotplate.

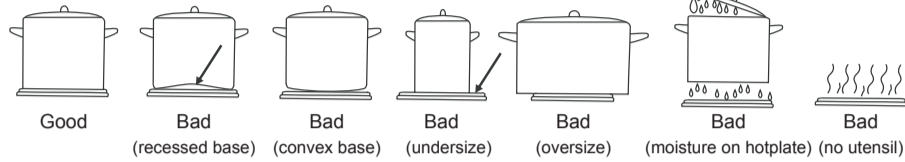

Cleaning

Turn off the mains to the equipment before carrying out any maintenance and wait for it cool down. We advise using lukewarm water and detergents to clean enameled elements. Never use abrasive products. Rinse the glass worktop with water and dry using a soft cloth. Use sponges or a moist cloth to clean the tops, and remember that water in excess can damage the electric elements. Clean tough stains using non abrasive detergents, or warm vinegar. Clean the electric tops using a moist cloth, then lightly oil the the top when it is still warm. Only licensed repairers should service the appliance.

Installation

Electrically-connected appliances with three-pole cable are set up for operation with alternating current at the voltage and frequency indicated on the rating plate. Look at the connection wiring diagram. The earth conductor is yellow/green. The connection to the electricity supply must be made by a qualified person and following current UK regulations. When the appliance is to be installed above a built-in oven, the two appliances must be connected separately. The supply cable must be positioned so that no part can reach a temperature 50°C higher than ambient temperature. Also check that the supply system has an effective earth connection and corresponds to the standards in force and that the breaker can be reached easily after the appliance is installed.

Fitting guidelines

The voltage rating of the hob heating elements is 220-240V. Appliances with three-pole cable are set up for operation current at the voltage and frequency indicated on the rating plate. Look at the connection wiring diagram. The earth conductor is yellow/green. The connection to the electricity supply must be made by a qualified person and follow current UK regulations. When the appliance is to be installed above a built-in oven, the two appliances must be connected separately, to make it easier to take the appliances out and to ensure electrical safety.

4

Inserting and fixing the hob

Before inserting the hob into the worktop, place the adhesive seal "s" around the underside edge of the hob. It is important to fix this gasket evenly, without gaps or overlapping, to prevent liquids from seeping underneath the hob.

- Place the gasket around the bottom edge of the hobs as shown in the illustration overleaf.
- Place the hob in the installation opening and push it down so that the hob is resting firmly on the cabinet.
- Secure the hob in position using the fixing brackets supplied.

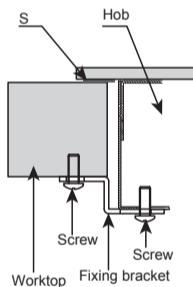

Secure the hob to the underside of the worktop, using the fixings provided. Screw one end of the bracket into the pre-drilled holes in the underside of the hob. The other end of the bracket should be located underneath the worktop to secure the hob in position.

Note 1:

The minimum height of any adjacent units (including light pelmets) is 450mm, unless they are manufactured from a material resistant to fire (steel, ceramic tiles for example).

Note 2:

No overhanging surface, cooker hood or exhaust system are permitted within 750mm above burner tops.

Note 3: Leave minimum 50 mm clearance between the base of the appliance and any combustible surface. Never leave the packing components (plastic bags, nails, foamed polystyrene, etc) within reach of the children, as they are a potential source of danger.

The hob has a special seal which prevents liquid from entering the cabinet. Follow these instructions in order to correctly apply this:

Seal:

Detach the seals from their backing, so that the transparent protection still adheres to the seal itself. Turn the hob over and correctly position the seal under the edge of the hob itself, so that the outer part of the seal perfectly matches the outer edge of the hob. Evenly and securely fix the seal to the hob, pressing it firmly in place.

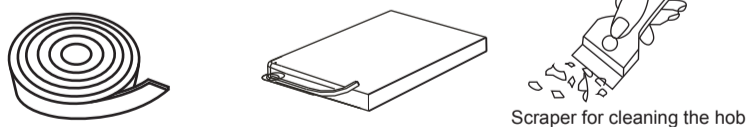

CLEANING AND MAINTENANCE

-Do not use cleaning products containing abrasive materials for the cleaning and maintenance of the glass front panel.

-When cleaning do not use cleaning agents with a strong abrasive effect, eg. scouring powders containing an abrasive, abrasive compounds, abrasive stones, pumice stones, wire brushes etc. These will scratch the hob surface, causing irreversible damage.

-Large spillages that are firmly stuck to the hob can be removed by a special scraper (not included with hob); but be careful not to damage the ceramic hob frame when doing this.

Caution!

The sharp blade should always be protected by adjusting the cover (just push it with your thumb). Injuries are possible so be careful when using this instrument and keep out of reach of children. Appropriate gentle cleaning or washing products are recommended, eg. non-scratch cream. Alternatively, a solution of warm water with a little washing up liquid or cleaning products for stainless steel sinks can be used.

6

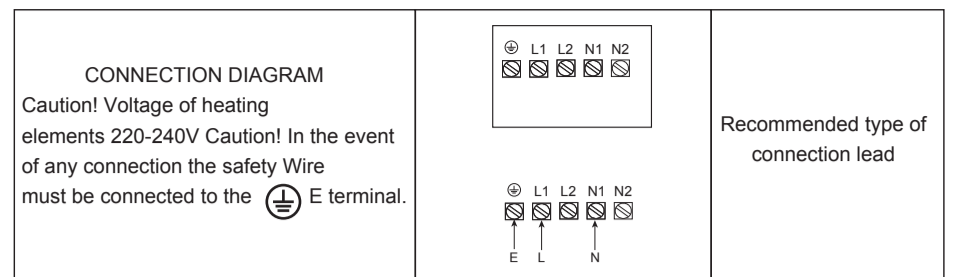

- If the cable is damaged or to be replaced, the operation must be carried out by a service agent or a suitably qualified professional.
- If the appliance is being connected directly to the mains, an omnipolar circuit breaker must be installed with a minimum opening of 3mm between contacts.
- The installer must ensure that the correct electrical connection has been made and that it is compliant with all applicable standards and safety regulations.
- The cable must not be bent or compressed.
- The cable must be checked regularly and replaced by authorised technicians only.



WARNING

Close the cable clamp after making the electrical connection. Close the terminal board cover by twisting it down.

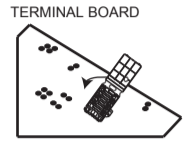

The manufacturer refuses all responsibility if the standards in force are not respected, or the instructions in this manual are not followed.

TECHNICAL INFORMATION FOR INSTALLATION PERSONNEL:

This appliance must be installed only by authorised personnel and in accordance with the regulations of UK electricity authorities. The wall and bench surfaces must be capable of sustaining temperatures of 95 degrees Celsius. All laminates, fixing adhesives and surfacing materials should be certified suitable for this temperature. Do not install it in a potentially flammable location, (eg. near curtains etc). As shown in the following diagram, cut a square hole in the worktop and install the hob.

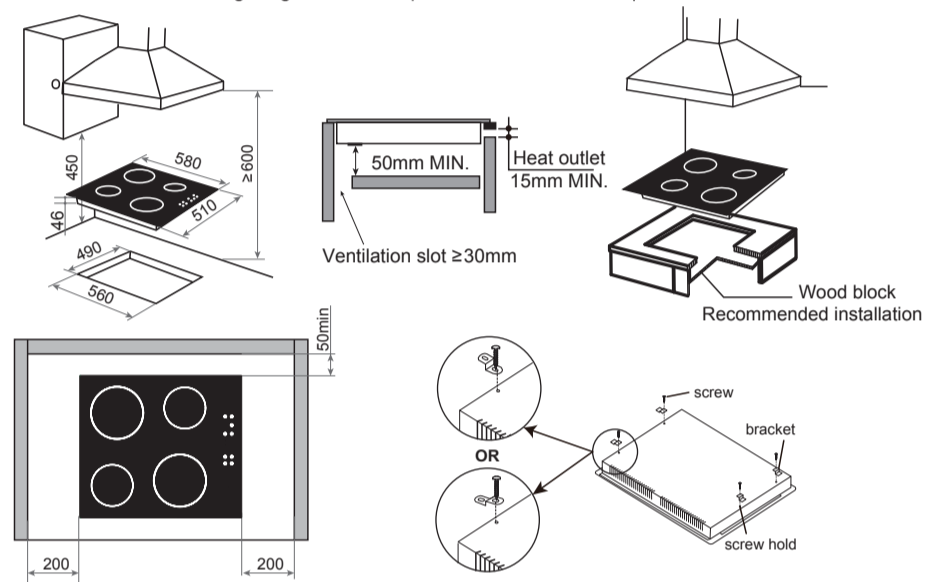

5

MALFUNCTION ELIMINATION

Malfunction	Eliminating guide
Hob doesn't work	•Check the wiring connection •Check the fuse size and limit is correct
There is some smoke when it is working	•It is normal the first time you use the appliance •Clean the area around the electric hob and wipe elements when cool.
The wire is damaged	•contact the Prima service department to change the relevant parts.



This appliance is labelled in compliance with European directive 2012/19/EU for Waste Electrical and Electronic Equipment (WEEE). By ensuring that this appliance is disposed of correctly, you will help prevent any possible harm to the environment and to human health which might otherwise be caused if disposed of in the wrong way.

The symbol on the product indicates that it may not be treated as normal household waste. It should be taken to a collection point for the recycling of electrical and electronic goods.

This appliance requires specialist waste disposal. For further information regarding the treatment, recovery and recycling of this product, please contact your local council, household waste disposal service or the shop where you purchased the product.

For more detailed information about treatment, recovery and recycling of this product, please contact your local council, household waste disposal service or the shop where you purchased the product.

Erp

	Symbol	Value		Unit
Model identification	--	PRCEH104	PRCEH106	
Type of hob	--	Built-in hob	Built-in hob	
Number of electric cooking zones and/or areas	--	4	4	
Heating technology (induction cooking zones and cooking areas, radiant cooking zones, solid plates)	--	Radiant cooking zones	Radiant cooking zones	
For circular cooking zones or area: diameter of useful surface area per electric heated cooking zone, rounded to the nearest 5 mm	∅	Big ring: 18,0 cm Small ring: 14.5 cm	Big ring: 18,0 cm Small ring: 14.5 cm	cm
For non-circular cooking zones or areas: length and width of useful surface area per electric heated cooking zone or area, rounded to the nearest 5 mm	L, W	N/A	N/A	cm
Energy consumption per cooking zone or area calculated per kg	EC _{electric cooking}	Big ring: 182 Small ring: 195	Big ring: 194 Small ring: 187	Wh/kg
Energy consumption for the hob calculated per kg	EC _{electric hob}	187	189	Wh/kg

7