

Sales Code: TSI303

Description: Bath Filler

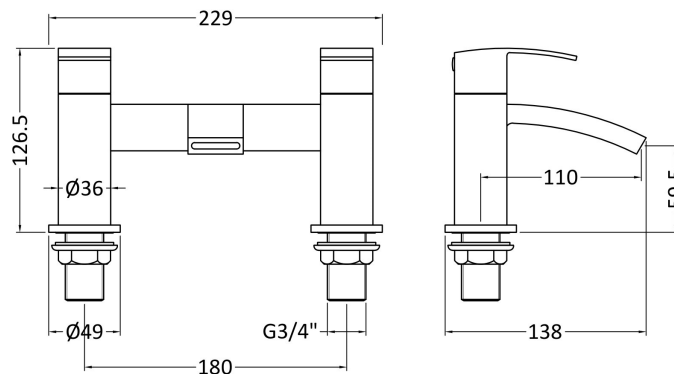

Product Dimensions

Height (mm):	127
Width (mm):	229
Depth (mm):	138
Length (mm):	
Nett Weight (kg):	2.3

Packaging Dimensions

Height (mm):	155
Width (mm):	218
Depth (mm):	150
Gross Weight (kg):	2.5

Packaging Data

Box Colour:	White Cardboard Box
Box Qty:	1
Label Size:	100 x 50
Label Colour:	White Label
Label Qty:	2

Outer Box Dimensions (If Applicable)

Height (mm):	260
Width (mm):	485
Depth (mm):	445
Length (mm):	
Gross Weight (kg):	15
Barcode:	5055369025534

Product Details

Country of Origin:	China
Fitting Instruction:	No
Product Material:	Brass
Control Type:	Manual
Waste Included:	Waste Not Included
Waste Type:	Not Applicable
WRAS Approval: No	Approval No: N/A
Valve/Cartridge Type:	1/4 Turn Ceramic Disc
Colour/Finish:	Chrome
Mount Type:	Deck
Operating Pressure (bar):	0.2

Flow Rates: (Litres Per Min)	0.1 bar: 10	0.5 bar: 28	1 bar: 38	2 bar: 0	3 bar: 0
Pipe Size:	22 mm (3/4" Bsp)				
Pipe Centres:	180 mm				