

# INSTALLATION, USE AND MAINTENANCE MANUAL

## DECORAL ELECTRIC WIFI



ALUMINIUM FLUID FILLED ELECTRIC RADIATOR

DEAR CUSTOMER,



WE THANK YOU FOR YOUR CONFIDENCE. BEFORE INSTALLING AND/OR USING THE PRODUCT, PLEASE READ CAREFULLY THIS MANUAL CONCERNING THE CORRECT INSTALLATION, USE AND MAINTENANCE OF THE APPLIANCE.

WE REMIND YOU AS WELL THAT THIS MANUAL MUST ACCOMPANY THE RADIATOR IN CASE OF TRANSFER TO ANOTHER PLACE OF INSTALLATION.

#### THE PACKAGE INCLUDES:

ALUMINUM RADIATOR EQUIPPED WITH PROVIDED WITH ELECTRONIC THERMOSTAT, FASTENING KIT COMPOSED OF TWO BRACKETS AND RELEVANT PLASTIC PARTS, SCREWS AND WALL BLOCKS, INSTRUCTION MANUAL.

#### TABLE OF CONTENTS

##### SUMMARY

1. WARNINGS .....	24
2. ELECTRICAL CONNECTIONS .....	25
2.1 DETAILS ON INSTALLATION IN THE BATHROOM.....	25
3. INSTALLATION OF THE APPLIANCE .....	26
3.1 RADIATOR WALL MOUNTING .....	26
4. ADJUSTMENT AND PROGRAMMING .....	29
4.1 CONTROL PANEL .....	29
4.2 FIRST START .....	29
4.3 DESCRIPTION OF OPERATING MODES .....	30
4.3.1 SIMPLE (MANUAL) MODE.....	30
4.3.2 PROGRAM MODE.....	30
4.3.3 TEMPORARY MODE .....	31
4.4 TEMPERATURE SETTING .....	31
4.4.1 TEMPERATURE SETTING IN SIMPLE (MANUAL) MODE.....	31
4.4.2 TEMPERATURE SETTING IN PROGRAM MODE.....	31
4.5 PROGRAMMING.....	32
4.5.1 CHANGING THE TIME SLOTS .....	32
4.5.2 RETURNING TO FACTORY PROGRAMMING.....	33
4.6 PARAMETERS .....	33
4.6.1 DETAILS OF SOME FUNCTIONS .....	34
4.7 TIMER .....	34
4.8 INFORMATION .....	34
4.9 KEY LOCK .....	35
4.10 RADIATOR STAND-BY .....	35
4.11 WI-FI CONNECTION .....	35
4.11.1 RADIATOR REGISTRATION AND PAIRING .....	36
5. RADIATOR CLEANING.....	39
6. FAILURES .....	39
7. WARRANTY .....	41
8. ENVIRONMENT .....	41
9. CHARACTERISTICS OF THE APPLIANCE.....	42
10. INFORMATION REQUIREMENTS FOR THE REGULATION (EU) 2015/1188 OF 28 APRIL 2015 .....	43
11. DECLARATION OF CONFORMITY.....	44

# 1. WARNINGS



The symbol shown here appears on a label on the radiator, whose meaning is: to avoid the overheating of the appliance, **DO NOT COVER THE RADIATOR** with clothes or other objects.

The radiator shall in no case:

- be covered in part or in full
- be in direct contact or too close to curtains, furniture, etc.



The radiator shall in no case be installed:

- in a niche
- at less than 10 cm from room corners
- under a socket-outlet
- in front of a socket-outlet
- above a shelf

The radiator must be fixed to a wall through the supporting brackets provided with the product.

Interventions on the appliance must be carried out by a qualified professional.

Reparations that require to open the fluid tank must be carried out by the manufacturer, its agents or the customer service.



**WARNING: some components of this product may become very hot and burn. Pay particular attention in the presence of children or disabled people.**

Children under the age of 3 must be kept away from the appliance unless they are supervised.

Children aged between 3 and 8 can only turn the radiator on or off, provided that it is positioned properly and that children have been taught the safe use of the appliance and have understood the possible correlated risks.



Children aged between 3 and 8 cannot connect the appliance to the power outlet, cannot adjust or clean the appliance and cannot carry out any kind of maintenance.

The appliance can be used by children aged no less than 8 and by persons with reduced physical, sensory or mental capabilities, or who do not have proper experience and knowledge, provided that they are supervised, or they have been instructed on safe use of the appliance and have understood the inherent risks.



Do not allow children to play with the appliance.

Cleaning and maintenance intended to be carried out by the user shall not be performed by unattended children.

This appliance is filled with a precise quantity of oil.

Any reparations requiring the opening of the oil tank must be carried out only by the manufacturer or its technicians, that should be contacted in case of oil leaks; when the appliance is scrapped, it is necessary to comply with regulations concerning the disposal of oil.

## 2. ELECTRICAL CONNECTIONS

### IMPORTANT



During installation, maintenance and cleaning, the appliance must not be powered.

The appliance must be powered only with 230 Vac voltage.

The radiator is supplied with a power cable with 3 wires as per table below:

Brown	Phase
Blue or Grey	Neutral
Black	Pilot wire

The power cable must be absolutely connected to power supply through a junction box positioned at 25 cm from the floor and without using any power plug.

### WARNING



The Pilot Wire is intended for radiators sold in France.

If the black "pilot wire" is not used, safety standards impose to insulate it and not to connect it for any reason to the ground wire.

It is compulsory to install a multipolar switching device. The minimum separation distance between contacts shall be at least 3 mm.

It is compulsory that the power supply circuit of the appliance is protected by a high sensitivity differential protection device.

Do not introduce and do not try to penetrate with metal objects into the side of the radiator containing the adjustment electrical system (right side). If the power cable is damaged, it must be replaced only by a qualified electrician.

### 2.1 DETAILS ON INSTALLATION IN THE BATHROOM

Installation must be compliant with the standards and laws in force in the country of installation.

The radiator is in class II and with IP24 electrical protection. In the bathroom, it can be installed in areas 2 and 3 (see figure) only if the control device cannot be touched by people that are using the shower or the bath.



In the bathroom, protect the power line with a high sensitivity 30 mA differential protection device

Install a multipolar switching device. The minimum separation distance between contacts shall be at least 3 mm.



figura n°1

# 3. INSTALLATION OF THE APPLIANCE

To achieve the best results in terms of heat output and comfort of your appliance, we recommend to install the radiator, if possible, under a window or near areas with high heat loss of the room to heat. The radiator must not be installed in a niche or under a power outlet.

Curtains, furniture or other objects that may obstruct the correct heat distribution must be placed at a minimum distance of 50 cm from the front of the radiator.

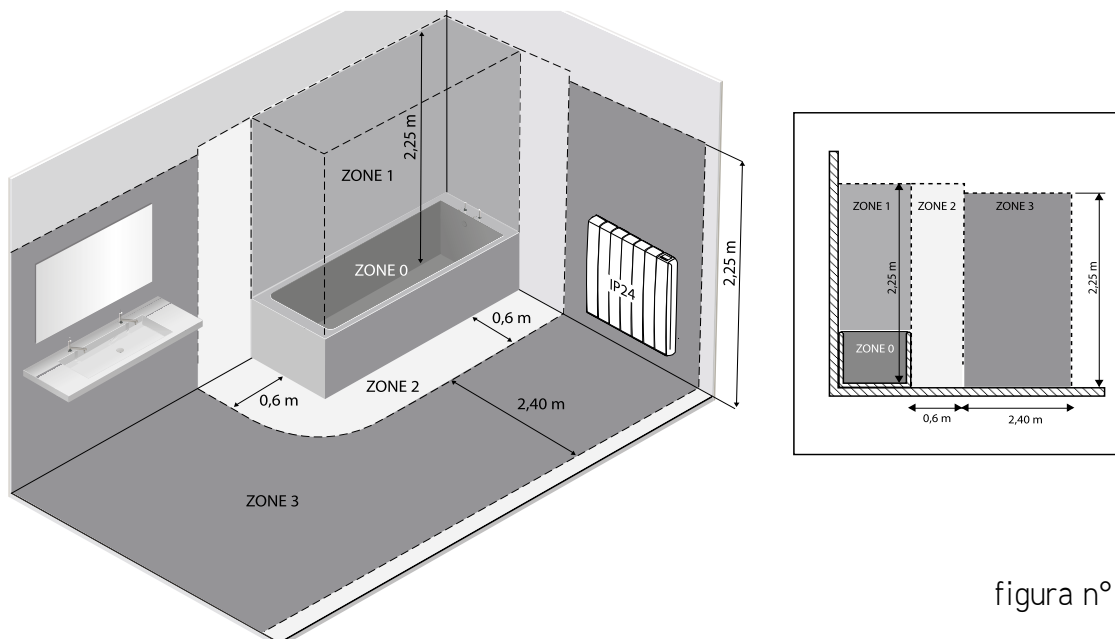
Respect a distance of at least 10 cm from the lower edge of the radiator and the floor.

Respect a distance of at least 30 cm from the top edge of the radiator and the shelf above it.

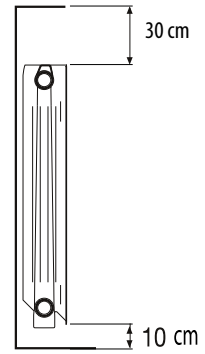

## 3.1 RADIATOR WALL MOUNTING

The radiator must be fastened to a wall through the suitable mounting brackets provided with the product. The fastening system is composed of:

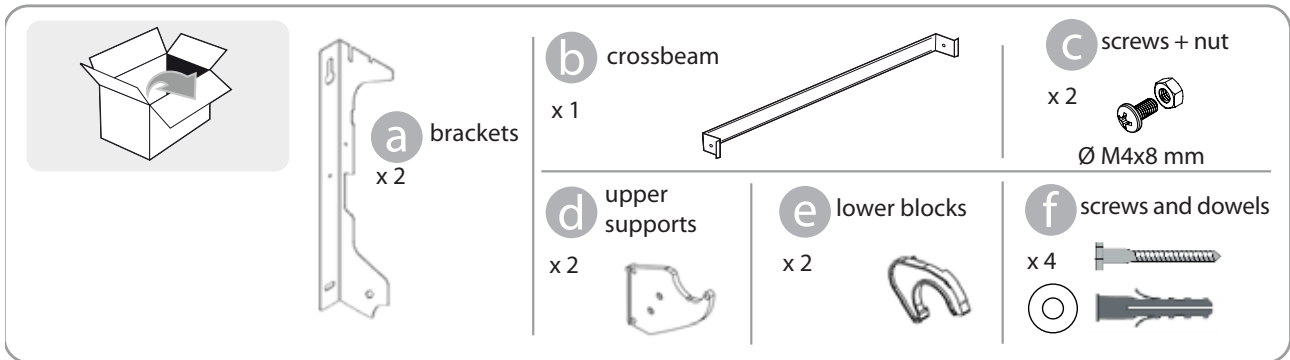

Follow the steps illustrated below:

1. Screw the crossbeam **b** to the two brackets **a** using screws **c**.

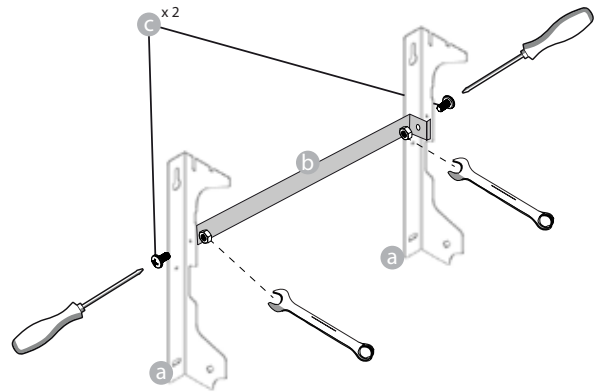

2. Choose the radiator position, refer to the warnings of paragraphs 1, 2 and 2.1. Depending on the position chosen, place the bracket **a** on the floor

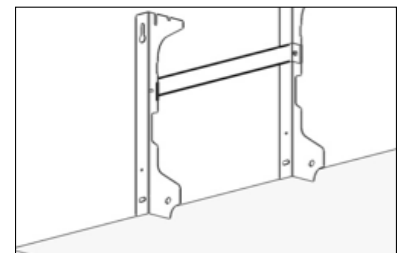
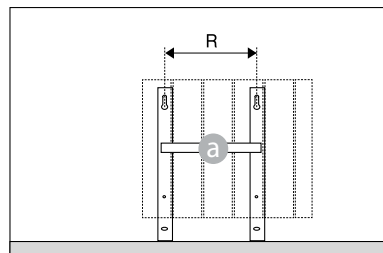

	Number of sections/power				
	4 / 750W	5 / 1000W	7 / 1250W	9 / 1500W	11 / 1800W
Distance R (mm)	160	240	240	560	640

3. Using a pencil, mark the position of holes **T1** and **T2**.

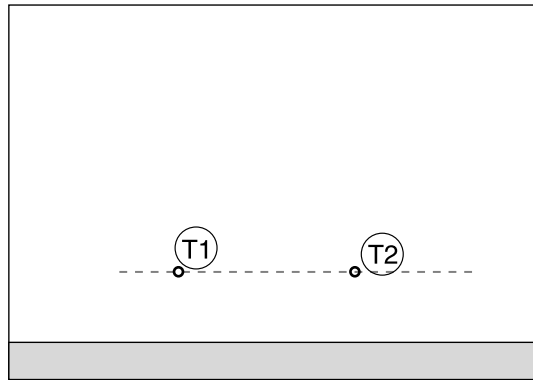
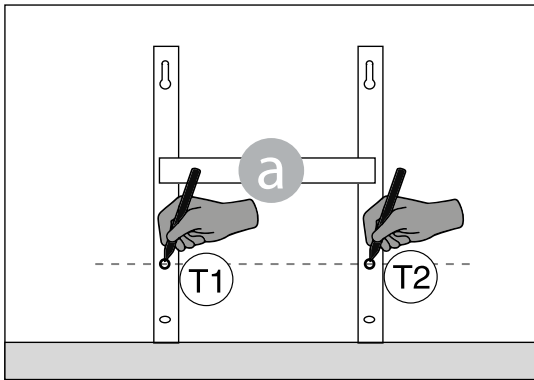

4. Marked points **T1** and **T2** correspond to the position of the holes for the lower screws. Place the bracket so that the lower slots of the bracket match the marks **T1** and **T2**:

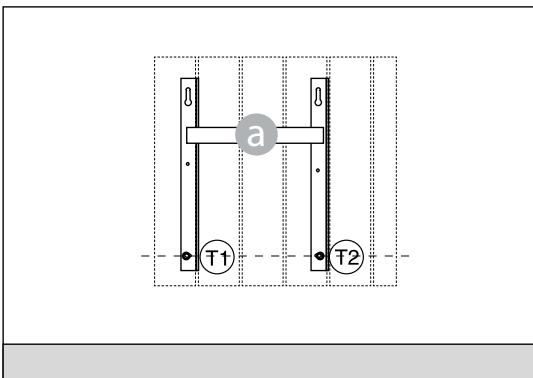
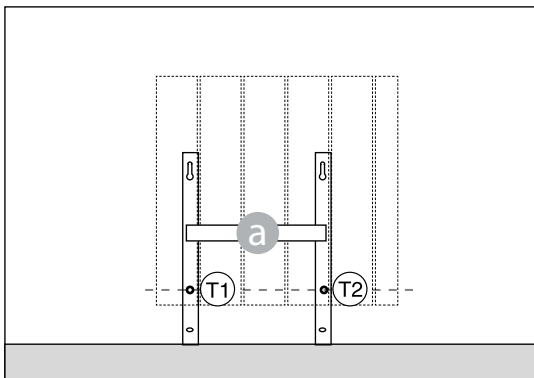

5. Using a spirit level, check that the bracket is straight and mark the position of the two upper holes **U1** and **U2**.

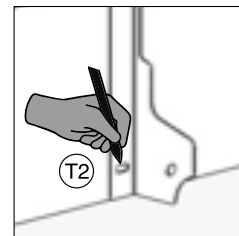
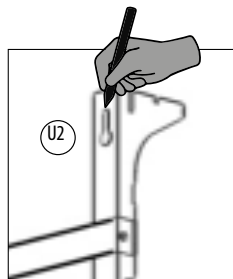
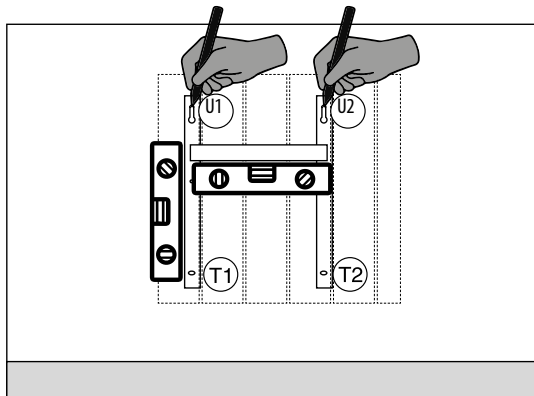

6. Depending on the type of wall, select suitable screws and dowels, the screws and dowels supplied may not be suitable for the type of wall of your home. Drill as indicated by the holes marked and then insert the blocks in the wall.

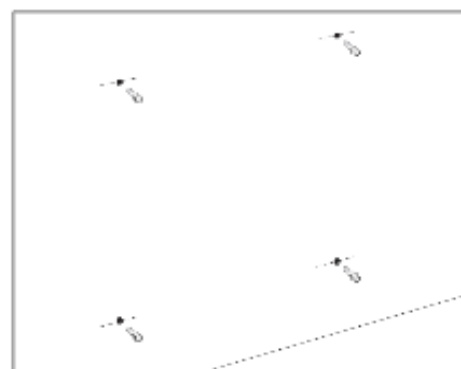
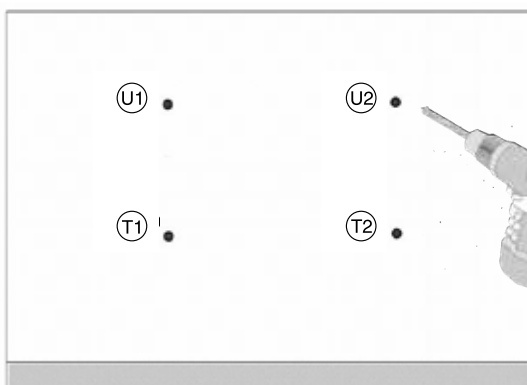

7. Position the bracket **a** and insert the screws with washers. Then tighten the screws::

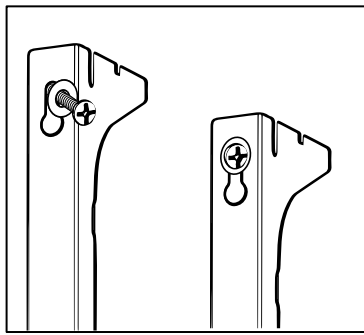

8. Position **d** upper plastic parts of the bracket:

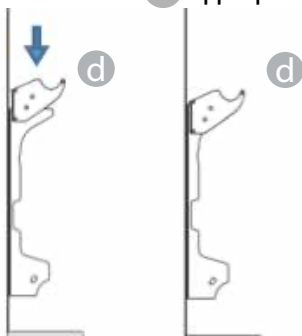

9. Fit the two **e** lower clamps and rotate them until you hear a first click.

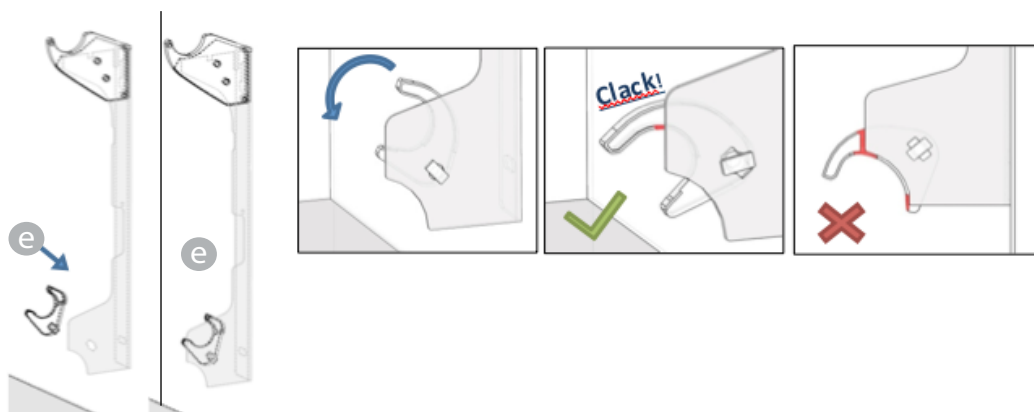

10. Position the radiator by leaning it on the upper part of the brackets and then rotating it. Push the radiator until it is automatically locked by lower plastic clamps **e**.

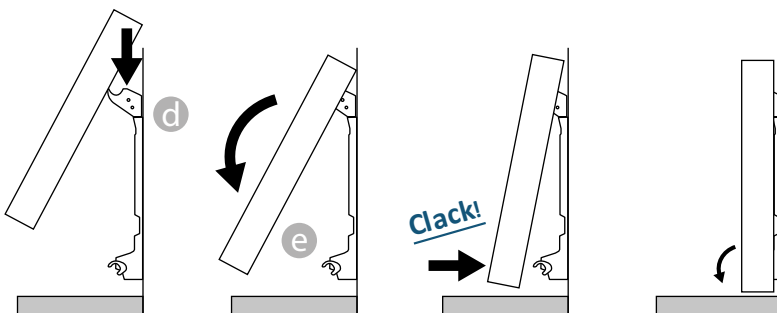

The operation is over only when locking hooks are blocked and the radiator is fixed on the wall, without any possibility of movement. In any case the minimum distance of the radiator from the floor must be 100 mm.

11. If necessary, remove the radiator and operate on the lower plastic clamps by moving them horizontally and then rotating them:

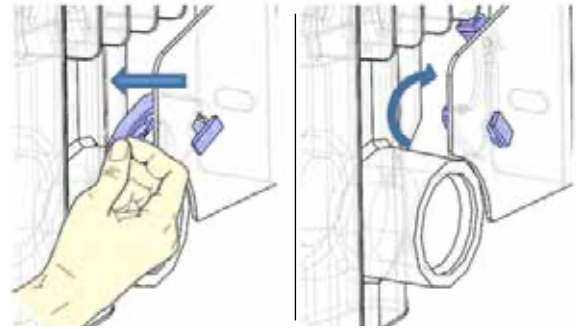

## 4. ADJUSTMENT AND PROGRAMMING

### 4.1 CONTROL PANEL

The appliance has an ON/OFF switch on the rear of the right plastic side (1).

To power the radiator, position the switch to I.

To switch off the radiator, position the switch to 0.

When the radiator is switched on again using the switch, the new setting of current date and day may be required.

Use the knob (2) to select the operating mode and increase or decrease the set values (+/-); press the knob to confirm the selection.

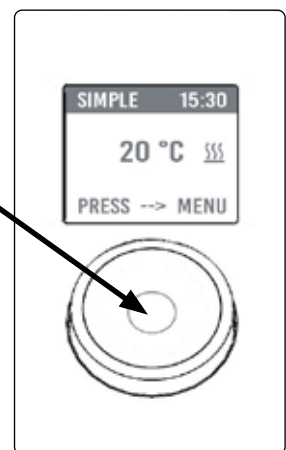
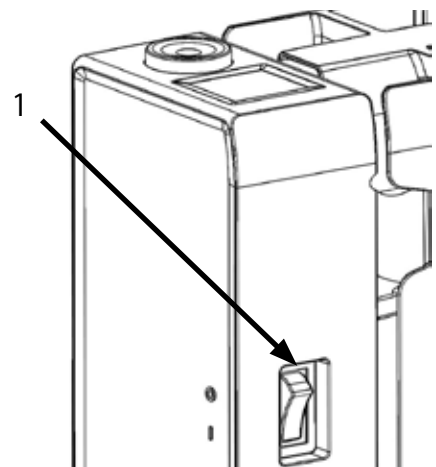

### 4.2 FIRST START



Turn the knob, move to the desired language and select it by pressing the knob.



Set time and date.



The manual (simple) operating mode is selected, the set temperature is 20 °C.



## 4.3 DESCRIPTION OF OPERATING MODES

Press the knob to access the MENU, press again to select MODE item and select one of the operating modes:

- SIMPLE (manual)
- PROGRAMMING
- TEMPORARY

A box on the display indicates the mode you are selecting, press the knob to confirm the selection.

Select  to return to the previous menu.

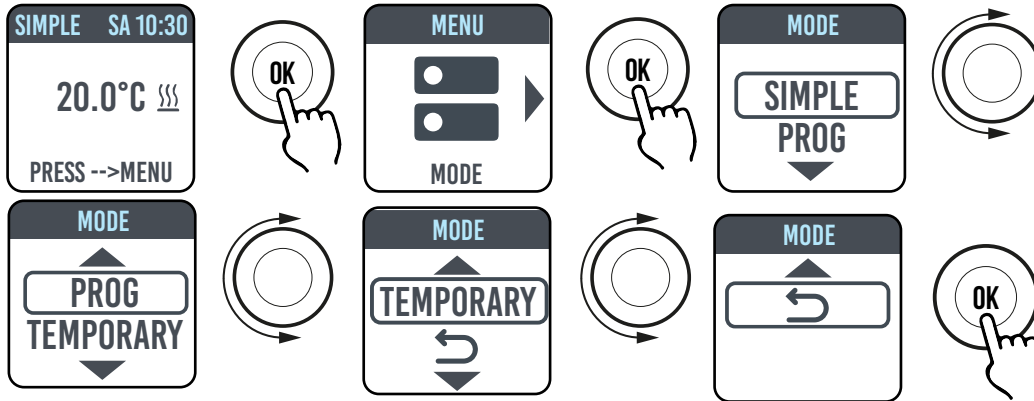

### 4.3.1 SIMPLE (MANUAL) MODE

The appliance maintains the set temperature.

The display shows the set temperature and, if the radiator is in heating phase, the  symbol.

This symbol is steady if the radiator is in heating phase or it flashes if the radiator operates intermittently because the room temperature is close to the set temperature (adjustment operation).

To change the set temperature, turn the knob and confirm by pressing it.



### 4.3.2 PROGRAM MODE

When the appliance is in this mode, the radiator follows the program defined for each day of the week. Upon the first switching on, the following program is preset:

	First operating time slot in Comfort mode	Second operating time slot in Comfort mode
Monday to Friday	6:30 ÷ 8:30 am	5:00 ÷ 11:00 pm
Saturday and Sunday	8:00 ÷ 11:00 pm	----



The display shows the graphic representation with the daily program and the set temperature for the current time.

The program can be changed according to your needs and three different operating periods in Comfort mode can be set for each day (see paragraph 4.5).

### 4.3.3 TEMPORARY MODE

The selection of this mode allows setting a temperature different from the programmed/set temperature for a limited period of time, ranging from 30 minutes to 24 hours, after which the appliance returns to operate at the previous temperature selected in SIMPLE or PROGRAM mode.

When this mode is activated, the display shows the time remaining before returning to the previous mode (countdown).



The temporary operation can be changed or stopped at any time. Turn the knob to display a menu that allows cancelling or changing the previous settings.

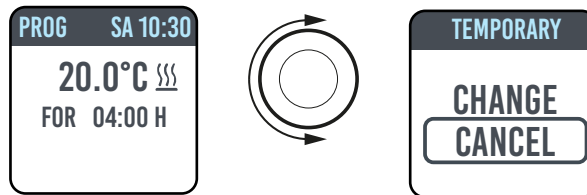

## 4.4 TEMPERATURE SETTING

### 4.4.1 TEMPERATURE SETTING IN SIMPLE (MANUAL) MODE

Turn the knob to change the set temperature, press the knob to confirm the selection. The maximum default temperature is 30 °C, but it can be changed using "MAX TEMP." parameter of PARAMETERS/LIMITATIONS menu.

The minimum configurable temperature is 12 °C, below this value the appliance sets to the freeze protection temperature of 7 °C.

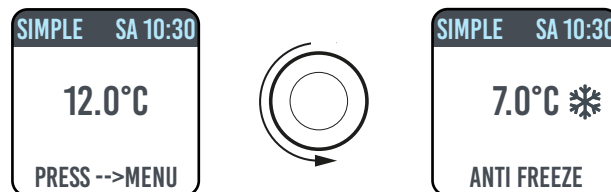

### 4.4.2 TEMPERATURE SETTING IN PROGRAM MODE

In PROGRAM mode the set temperature depends on the set time and the program.

The factory set COMFORT mode temperature is 20 °C.

The factory set ECO (night) mode temperature is 18 °C.

To change COMFORT and ECO temperatures, access the PROGRAMMING menu, select the temperature to be changed and change it by turning the knob and confirming the selection.

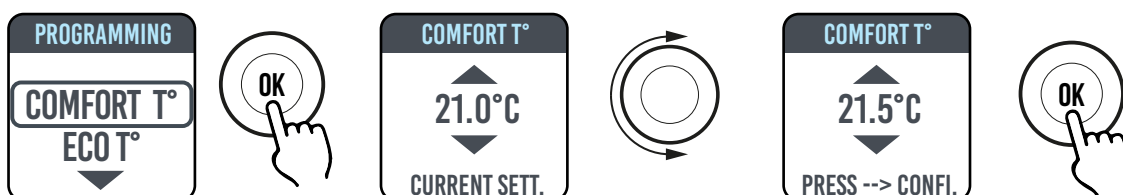

The maximum default temperature is 30 °C, but it can be changed using "MAX TEMP" parameter of PARAMETERS/RESTRICTIONS menu.

In PROGRAM mode, it is possible to change COMFORT and/or ECO temperatures by simply turning the knob: the new setting will be maintained until the new automatic temperature change set in the program triggers.

The display shows EXCEPTION and the time at which the previously set programming is restored.



The exception operation can be changed or stopped at any time. Turn the knob to display a menu that allows cancelling or changing the previous settings.



If a FREEZE PROTECTION temperature (7°C) is set, the programming is interrupted. To reset the programming, when you return, it is necessary to set the temperature to a value other than 7 °C.

## 4.5 PROGRAMMING



In this menu it is possible to:

1. Set the Comfort temperature (see paragraph 4.4.2).
2. Set the ECO temperature (see paragraph 4.4.2).
3. Program each day of the week.
4. Return to factory preset programming.

In PROGRAMMING/DAY PROG, turn the knob to select the day to be programmed. Press the knob to start programming.

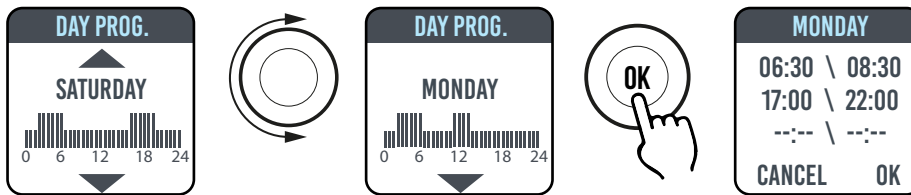

Each day of the week can be programmed separately, and for each day 3 operating time slots can be configured in Comfort mode, depending on your needs.

If you do not wish to use all the 3 time slots, simply do not select them.

The time slot you are selecting is shown in a box.

### 4.5.1 CHANGING THE TIME SLOTS

Turn the knob to highlight the time slot you want to change and select it by pressing the knob. The selected time slot starts flashing.

To change the time slot, turn the knob and press it to confirm the selection. The minutes can be selected in 30-minute intervals. The appliance will automatically position on the next value to be set.

At the end of programming, the Comfort mode time slots can still be changed by moving back with the knob.

Select OK to confirm programming.

When one day has been programmed, the appliance allows copying the programming just set to other days, by simply selecting the days for which you want to copy the program and then OK

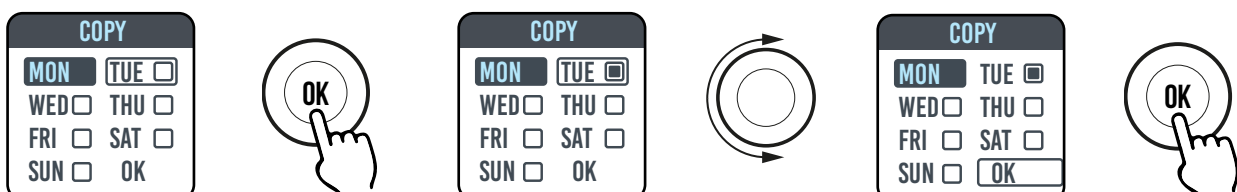
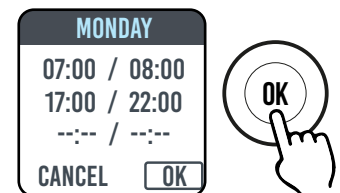
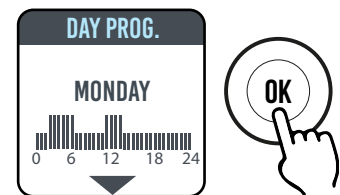

## 4.5.2 RETURNING TO FACTORY PROGRAMMING

In PROGRAMMING select DEF. PROG. and press the knob. Select  to cancel the operation. Press RESET to confirm the return to the factory programming.

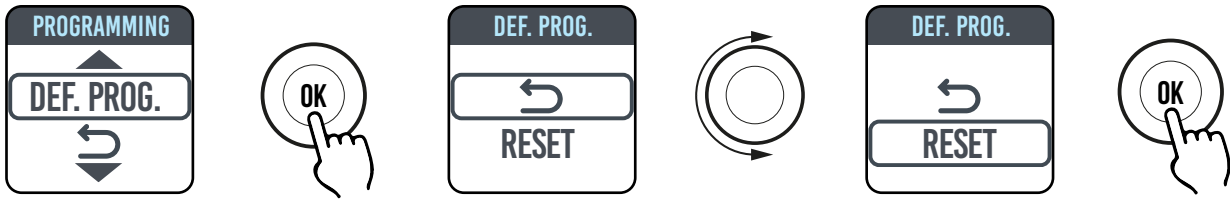

## 4.6 PARAMETERS

From SIMPLE / PROGRAM / TEMPORARY menus, press the knob to access the MENU and then select PARAMETERS to adjust/set the following parameters:

- WINDOW OPENING DETECTION (WINDOW):** enabled/disabled type function. In the factory setting this function is disabled.
- ASC (Adaptive Start Control):** enabled/disabled type function. In the factory setting this function is disabled. If this parameter is enabled and the appliance is in PROGRAM mode, the electronics activates the radiator in advance (up to 2 hours) so as to ensure that the room reaches the set temperature at the desired time. ASC is displayed when this parameter is enabled and has triggered, if it is enabled but has not triggered ASC is not displayed.
- LANGUAGE:** allows selecting the language.
- PILOT WIRE:** enabled/disabled type function. In the factory setting this function is disabled. FP is displayed when this parameter is enabled and has triggered, if it is enabled but has not triggered ASC is not displayed. The Pilot Wire is the black wire inside the power cable, used in France for control from remote control unit (see paragraph 2 "Electrical connections").
- Temperature CALIBRATION:** allows calibrating the temperature probe (+/- 5 °C) if the temperature shown on the radiator display is different from the temperature measured in the room.

The display shows the ambient temperature measured by the radiator in the position where it is installed and the possible calibration already set.

The temperature of a room is not uniform, therefore it is possible that the temperature measured by the radiator is different from that of another position in the room. The calibration function allows compensating this difference.

Before using this function, the radiator must operate for at least 6 hours to stabilise the ambient temperature.

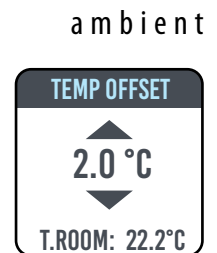

Example 1 :

If the temperature set on the radiator is 20 °C but the temperature measured in the room is 22 °C, set the calibration to 2 °C.

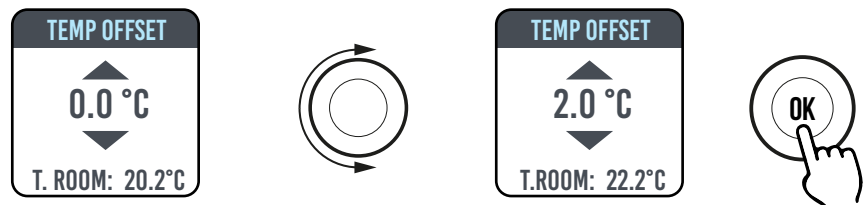

Example 2 :

If the temperature set on the radiator is 20 °C but the temperature measured in the room is 18 °C, set the calibration to -2 °C.

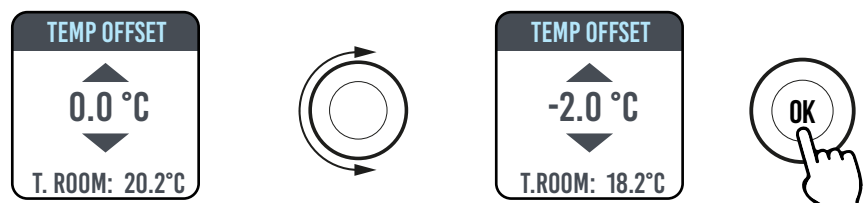

**6. FACTORY SETTINGS:** allows returning to the factory parameter setting. Select VALIDATE and press and hold the knob for approx. 5 seconds to reconfigure the factory settings.

**7. RESTRICTIONS:** Select this option in the PARAMETERS menu to:

- Set the maximum permitted temperature: the maximum temperature can be adjusted from 22 to 30 °C, 30 °C is the factory setting
- Lock the use of PARAMETERS or the use of both PARAMETERS and PROGRAMMING (PAR & PR). No menu is locked in the factory settings.

To lock the use of parameters or programming, it is necessary to enter a PIN code.

The PIN code is: 139.

The PIN cannot be changed.

When the limitations have been activated, the PIN is required to access the locked menus.

In the RESTRICTIONS/MENU LOCK menu, the locked function is marked with a dot.

To remove the lock, enter the RESTRICTIONS/MENU LOCK menu and select NONE.

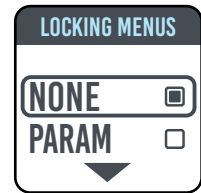
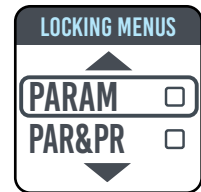

#### 4.6.1 DETAILS OF SOME FUNCTIONS

##### WINDOW OPENING DETECTION FUNCTION

The radiator is able to identify whether a window has been opened through detection of a quick ambient temperature reduction (5°C at least in a maximum of 30 minutes). If this happens, the radiator switches off for 30 minutes and then it restarts working in the previously set mode if it detects a subsequent increase in temperature of at least one degree centigrade (the window has been closed), otherwise it remains off for an additional 30 minutes.

When the function is activated and the window opening is detected, the displayed symbol of the window flashes.

##### PILOT WIRE MODE (FOR FRANCE ONLY)

In this mode the radiator is controlled by a remote-control unit.

To use this function, the corresponding parameter must be enabled in the proper menu.

#### 4.7 TIMER

From SIMPLE / PROGRAM menus, press the knob to access the MENU and then select TIMER to adjust/set:

- The automatic switching to summer/winter time, of enabled/disabled type. The factory setting is: enabled.
- Adjusting time and date

#### 4.8 INFORMATION

From SIMPLE / PROGRAM menus, press the knob to access the MENU and then select INFO to access the following information:

- Ambient T.: is the ambient temperature measured by the probe on board the radiator (See also par. 4.6, point 5).
- Radiator model
- Software version
- Radiator consumption in kW/h. The following consumptions are shown:
  - a. Daily, for the previous 7 days.
  - b. Monthly, for the previous 12 months.
  - c. Annual, for the previous 4 years.
  - d. Total.

## 4.9 KEY LOCK



It is possible to lock the device to avoid an improper or unintentional use, for instance for children protection or in a public space. To lock the keys (knob) from one of SIMPLE/PROGRAM/TEMPORARY modes, press and hold the knob for a few seconds and then select LOCK.

The operating mode remains shown on the display, if you touch the knob on the display the padlock symbol appears to indicate the lock.

To unlock the operation, press and hold the knob and then select UNLOCK.

## 4.10 RADIATOR STAND-BY



From SIMPLE/PROGRAM menus, press the knob to access the MENU and then select OFF to set the radiator to stand-by mode (radiator off but connected to power supply).

A long beep signals the stand-by status.

In this status OFF is displayed.

In OFF mode, turn or press the knob to display ON and OFF, select ON to switch the radiator back on. A double short beep signals the switching on.

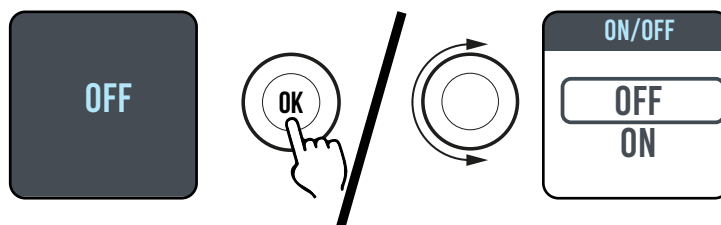

## 4.11 WI-FI CONNECTION



You can manage your radiator heating system from your smartphone through the Wi-Fi of your home and, using the DOMUS ONE APP, you can also send simple voice commands from your Google or Alexa assistant if you have one.

### Minimum system requirements.

2.54 GHz Wi-Fi network, with the following characteristics:

- WPA-PSK
- WPA2-PSK
- Open network (no security implemented)

Please note that no other system is supported, e.g. WEP (WEP systems still in use are not secure).

SSID Wi-Fi network passwords and names cannot have more than 50 characters.

The radiator is factory-set to be connected to the Wi-Fi network, when the radiator is ON the flashing icon appears on the display.

The connectivity function can be disabled on the radiator: access the MENU, select  and then Wi-Fi, the connection mode can be enabled/disabled.



In the same menu it is also possible to:

- Select STATUS to check the radiator connection status: connected / not connected. On the display, the  icon is steady ON if the radiator is connected and flashes if the radiator is not yet connected. Follow the procedure described below to connect it.
- Select RESET CONN. to cancel the pairing of the radiator to the Wi-Fi network.

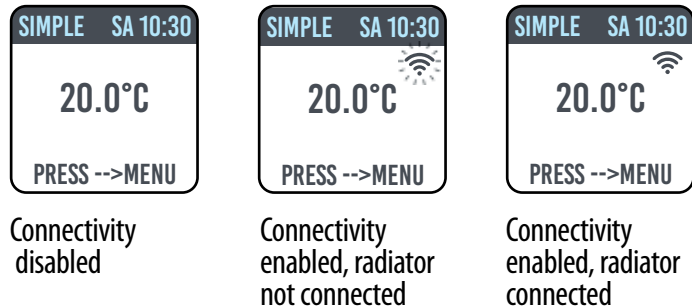

To manage your radiator from the APP please follow the steps below, then described in more detail:

- a) Download the DOMUS ONE APP on your phone, you can find it on



- b) If you are downloading the APP for the first time, you will have to create your account (4.11.1.1)  
c) Connect the radiator to your Wi-Fi network via the APP DOMUS ONE (4.11.1.2)  
d) Add the new radiator to the list of devices that can be managed via your phone (4.11.1.3)

#### 4.11.1 RADIATOR REGISTRATION AND PAIRING

**NOTE 1:** before you start make sure that the phone is connected to the same network that you want to connect the radiator to (home Wi-Fi network), to do so go to the phone's Wi-Fi settings and connect it to your network.

**NOTE 2:** Always agree if the Domus APP requests permission during the association process.

##### 4.11.1.1 Creating your account:

After downloading, open the "Domus One" APP on your phone. If you open the APP for the first time, you have to register to the "Domus One" platform by creating a new account; this is no longer required if and when you will add further radiators to the system. You will be prompted to enter a valid email address, your name and a password, then press "OK" and your Domus One account is ready. Then you will be automatically connected to your new account.



##### 4.11.1.2 Connecting the radiator to your home WI-Fi network:

As displayed in fig.02 select "Wi-Fi" and press "+ ADD NEW THERMOSTAT", fig. 03 will be displayed.

If the radiator (thermostat) has already been connected to your Wi-Fi network ( symbol on the radiator steady ON), press "YES" and follow instructions from point 4.11.1.3.

If the radiator is not connected to your Wi-Fi network (new radiator or radiator with  symbol flashing), press "NO", a new screen will

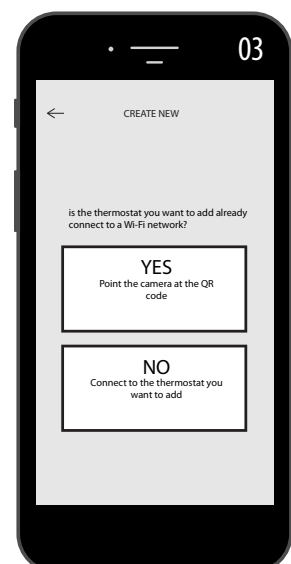

be displayed (figure 04):

Enter the network password if required. Press, "CONFIGURE", the screen shown in figure 05 will be displayed.

Press "GO TO WI-FI SETTINGS", the Wi-Fi setting page of the operating system will be displayed (figure 06).

The Wi-Fi network "DOMUS WI-FI..." of the radiator will be displayed.

**Note:** if the DOMUS network does not appear, check in the phone's Wi-Fi settings that the "automatic reconnection" option is not selected for your home network. In case remove this setting.

In your phone, select the Domus Wi-Fi network.

Wait for the successful connection to the Wi-Fi network. and then return to the APP.

Wait until successful connection message is displayed on your phone and, if requested, confirm. Depending on the phone this may take up to 2 minutes.

A Wi-Fi connection message appears on the radiator and, once connected, the  symbol on the display is steady ON.

Now your radiator is connected to your home Wi-Fi network, and you can add it to the list of radiators to be managed via your phone or to other phones with DOMUS ONE APP, as described in the following paragraph.

#### 4.11.1.3 Adding the new radiator to the list of devices that can be managed via your phone:

Log in to the APP.

The following screen is displayed on the radiator (figure 07):

Press "+ ADD NEW THERMOSTAT", the screen shown in figure 08 is displayed.

Press "YES", you will be prompted to frame the QR code on the right side of the radiator.

Frame the QR code, a message will appear on your phone, press "CONNECT".

You will be prompted to give a name to the radiator and pair it to a group, for example you can give the name eBlitz 1000 W and pair it to the group "Living room", or create a new group, e.g. "Bedroom".

The Group and the radiator registered in this way will be displayed on the main page of the APP and you can start managing it from your phone.

Repeat the procedure described above for each new radiator.

To remove a radiator from your account, press and hold the name of the radiator for several seconds and then select "DELETE".

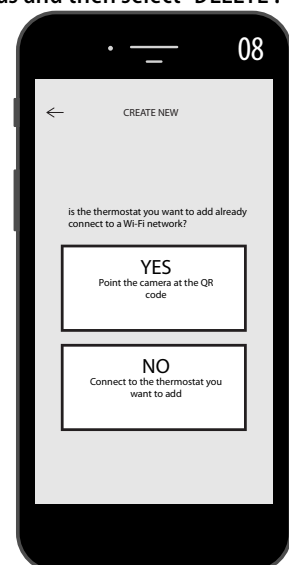
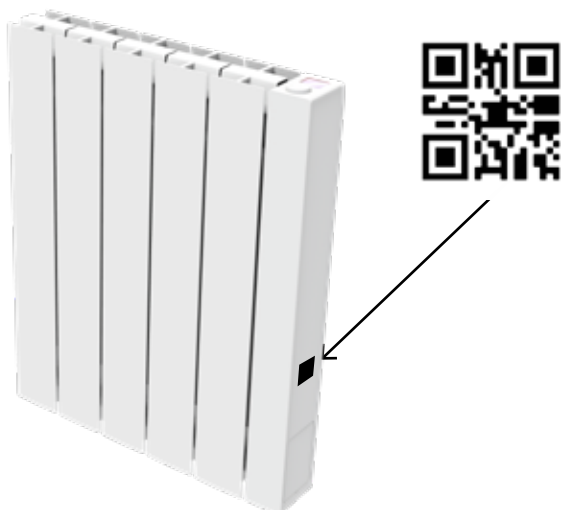
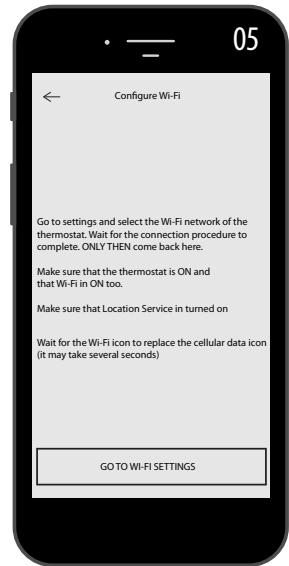



## 4.11.2 APP operation

From the APP, you can manage every single radiator, groups of radiators or even radiators in different buildings, you can set many of the functions of the radiator and its programming, as well as monitor the daily temperature to make sure that it meets your needs.

You can add new radiators to your personal list at any time and give them a name to easily recognise them.

If you have several radiators in the same room, we recommend grouping them together.





From the main APP page you can quickly switch a radiator off or on, or select it to change its parameters.

You will access a page where you can change the temperature set on the radiator or select a different operating mode from those already described in the previous sections on radiator operation.

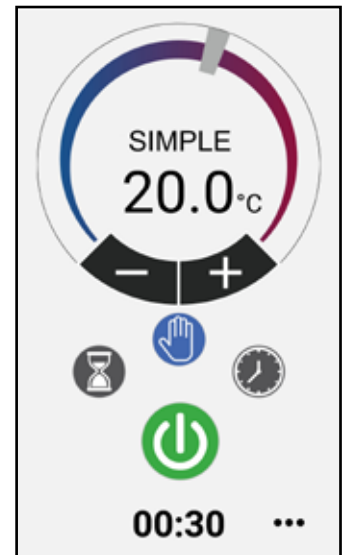
The main part of the screen shows the temperature, that can be changed by pressing "+" or "-" or sliding the cursor.

The lower part of the screen shows the selectable operating modes, the active mode is coloured, the other modes are grey.



- Basic (manual) mode 
- Programming mode 
- Temporary mode 
- radiator switching on and off 

Press the icon  in the upper right corner to access the page where it is possible to change the set parameters, activate or deactivate the various radiator functions, program the radiator, activate the child safety lock, display the temperature trend in the room.

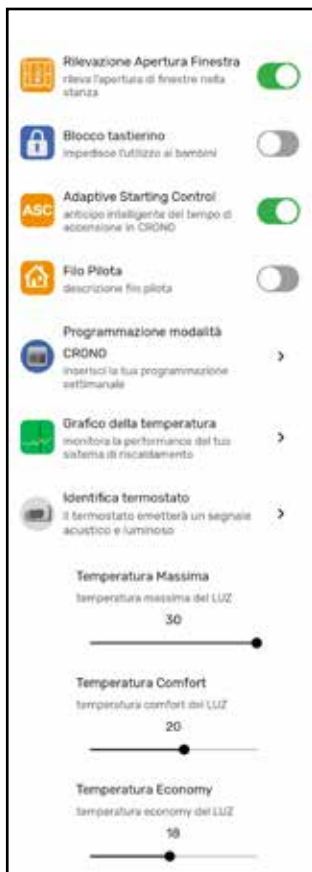

Programming from APP follows the same criteria as described for the radiator, with the possibility of setting three comfort operating time slots for each day; instead, it is not possible to copy programs from one day to another as in programming from radiator.



The APP also allows displaying the trend of the daily, the previous day or the previous week ambient temperature, and comparing it with the desired settings, so as to adapt the most suitable settings to your needs and manage consumption.

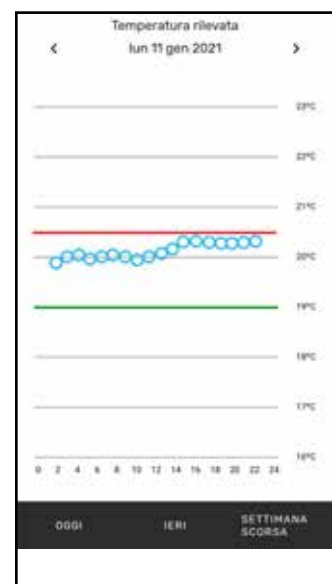

## 5. RADIATOR CLEANING

For your safety, before any cleaning operation, disconnect power supply.

Cleaning operations must be carried out with radiator off and cold.

Do not use abrasive or corrosive products to clean the heating body. Use, for instance, soapy water and then dry the body using a soft cloth.

To clean plastic components, controls and humidifier, use only a dry cloth and avoid contact with chemicals or alcohol.

## 6. FAILURES

In case of failure do not use the appliance, disconnect it from power supply and for the repair address only to a technician approved and authorized to operate on this product.

This appliance is filled with a precise quantity of mineral oil. Reparations that require to open the fluid tank must be carried out by the manufacturer, its agents or the customer service.

The manufacturer shall not be held responsible for damage to people, animals, or property due to tampering with or improper intervention to the radiator.

### TABLE OF TECHNICAL FAULTS

PROBLEM	STATE OF THE RADIATOR	PROBABLE CAUSE	SOLUTION
The radiator does not heat.	The display does not show any notice	No power supply.	Check that there is voltage and that the radiator switch is in I position.
	Radiator in PROGRAM mode	The program provides for operation in ECO mode	Check the programming setting
	Radiator in BASIC mode	Malfunction of resistor or adjustment board	Contact a Service Centre
The radiator does not ensure to reach the desired temperature in the room	Properly working	The radiator power is insufficient to meet the need of the room	Replace the radiator with a more powerful one or add another radiator.
	Properly working	The radiator position affects excessively the temperature detected in the room	Calibrate the temperature read by the radiator, see paragraph 4.6 PARAMETERS/CALIBRATION
The radiator is faulty	SENSOR ALARM is displayed	The temperature sensor is faulty	Contact a Service Centre
		Radiator temperatures too high	Check that the radiator is not covered.
The radiator heats continuously	Any	The radiator is installed near an air stream (entrance doors, ventilation holes in the wall)	Avoid installing the radiator near air streams
		The set temperature is too high	Correct the set temperature

PROBLEM	STATE OF THE RADIATOR	PROBABLE CAUSE	SOLUTION
Window opening detection does not work properly	Function enabled	Lowering of temperature in the rooms has not exceeded 5°C in the time provided or	----
		The position of the radiator does not allow the probe to detect the temperature correctly.	Relocate the radiator.
The PIN code is required	Locked parameters and/or programming	The parameters and/or programming have been intentionally locked	The PIN code to be entered is 139
Expansion noises in switching on and/or off phase	Any	Radiator supporting brackets are not centred and scrape on the radiator.	Position brackets properly.
The radiator leaks oil	Any	Defect of the heating body or lack of sealing in connectors.	Contact a Service Centre.
The wall behind the radiator gets dirty	Any	These signs are due to the quality of the air in the room and the formation of dust in the radiator or the fact that people regularly smoke in the room	Ventilate and keep the room and the radiator clean. Do not smoke in the room. This situation does not legitimate the replacement of the radiator under warranty.
The radiator is too hot	Radiator in heating phase	The radiator normally reaches high temperatures	High temperatures comply with safety standards, the radiator is designed to withstand them
The APP cannot find the home Wi-Fi network to which the phone is connected	----	During the APP installation, not all the required authorisations were provided, e.g. for geolocation.	Reinstall the APP and provide the authorisations required
The radiator does not connect to the Wi-Fi network even if the password and the network name are correct	----	The Wi-Fi network does not have the technical features required, see par. 4.11	Check that the Wi-Fi network complies with the required technical features and if necessary replace the router with an upgraded version.
The radiator does not connect to the Wi-Fi network	The radiator display does not show the symbol 	The connection mode is disabled on the radiator	Enable the connection mode on the radiator, see para. 4.11
You do not find the QR code to pair the radiator to the WI-FI network	Waiting for connection	The QR code label on the radiator side has been removed	You can also find the QR code on the back of the radiator.

## 7. WARRANTY

The body in aluminum alloy is warranted against manufacturing defects for 10 years from date of purchase. Electric and electronic components are warranted for 2 years from the date of purchase of the radiator. To validate your warranty, it is necessary to produce a document attesting the date of purchase (tax receipt, invoice, sales receipt).



For the validity of the warranty, the installation must comply with regulations and laws in force and must be carried out in a craftsman like manner.

Warranty does not cover components subject to standard wear or consumption, as well as damages resulting from transport or assembly.

## 8. ENVIRONMENT

The symbol applied to the appliance and shown here indicates that the product must be disposed of in separate collection for electrical equipment.



At the end of the life of the appliance, it cannot be eliminated as solid urban waste, but it must be sent to the collection center of your area or returned to the dealer when buying a new appliance of the same type and destined to the same purpose.

Separate collection of electric and electronic equipment is part of a policy on safeguarding, protecting and improving the quality of the environment and to avoid potential adverse effects on human health due to the presence of hazardous substances as classified by the European directives.



**Warning! Incorrect disposal of the appliance involves sanctions.**

When the radiator is eliminated, respect standards and laws in force for oil disposal.

## 9. CHARACTERISTICS OF THE APPLIANCE

IP24: appliance protected against water jets



Class II insulation class, double insulation

The radiator is composed of a body in die-cast aluminum and contains a fluid for internal heat transmission composed of highly refined mineral oil with high coefficient of heat transmission, featuring high resistance to oxygenation to aid a long duration and low viscosity.

The internal fluid is heated through a resistor with class II insulation.

Control and adjustment electronics ensure high accuracy in ambient temperature setting.

In case of temporary lack of power supply, the radiator can store the set programming and the time for about 2 hours.

The radiator can be connected to your home Wi-Fi network and you can easily control your radiators remotely through the "Domus One" App and also with the voice assistant. With the App you can connect each radiator to the Internet and pair it to your personal account. You can add new radiators to your personal list at any time and give them a name to easily recognise them.

N.B.: all the radiators are produced with an identification label that ensures traceability. Such label certifies compliance with BS electrical regulations.

Input voltage	230V +/- 10% AC 50/60 Hz	
Power	Mod. 750 W	750 W
	Mod. 1000 W	1000 W
	Mod. 1250 W	1250 W
	Mod. 1500 W	1500 W
	Mod. 1800 W	1800 W
Insulation class	Class II	
Water protection class	IP24	
Working temperature	0 ÷ 50 °C	
Consumption in standby mode	< 0,5 W	
Storage temperature	-15 ÷ 70 °C	
Working relative humidity	0 ÷ 85 % non condensing	
Type of setting	Integral proportion	
Temperature range	7°C ÷ 30°C	
Temperature setting resolution	0,5 °C	
Frequency band	2412 MHz ÷ 2474 MHz	
Maximum transmitted radio frequency power	17,5 dBm	

Model	Power	Nr of elements	Width	Height	Depth	Net weight
eBlitz Wi-Fi	W		mm	mm	mm	Kg
750 W	750	4	390	583	80	8
1000 W	1000	5	470	583	80	9,9
1250 W	1250	7	630	583	80	13,7
1500 W	1500	9	790	583	80	17,1
1800 W	1800	11	950	583	80	19,7

# 10. INFORMATION REQUIREMENTS FOR ELECTRIC LOCAL SPACE HEATERS IN ACCORDANCE WITH ANNEX II, POINT 3.A.I.2, OF THE REGULATION (EU) 2015/1188 OF 28 APRIL 2015 IMPLEMENTING DIRECTIVE 2009/125/EC.

Model identifiers: eBlitz Wi-Fi 750 W / 1000 W / 1250 W / 1500 W / 1800 W					
Item	Symbol	Value	Unit	Item	Unit
Heat output				<b>Type of heat output/room temperature control</b>	
Nominal heat output	P <sub>nom</sub>	0,75 / 1,0 / 1,25 / 1,5 / 1,8	kW	Single stage heat output and no room temperature control	No
Minimum heat output (indicative)	P <sub>min</sub>	n.d.	kW	Two or more manual stages, no room temperature control	No
Maximum continuous heat output	P <sub>max,c</sub>	0,75 / 1,0 / 1,25 / 1,5 / 1,8	kW	with mechanic thermostat room temperature control	No
Auxiliary electricity consumption				with electronic room temperature control	No
At nominal heat output	e <sub>lmax</sub>	0,75 / 1,0 / 1,25 / 1,5 / 1,8	kW	electronic room temperature control plus day timer	No
At minimum heat output	e <sub>lmin</sub>	n.d.	kW	electronic room temperature control plus week timer	Si
In standby mode	e <sub>lSB</sub>	< 0,5	W	<b>Other control options</b>	
				room temperature control, with presence detection	No
				room temperature control, with open window detection	Si
				with distance control option	Si
				with adaptive start control	Si
				with working time limitation	No
				with black bulb sensor	No
Contact details	MHS Radiators Unit 4 Genesis, Endeavour Drive Basildon, Essex, SS14 3WF Tel. +44(0)3455215666 email: enquiries@mhsradiators.co.uk - www.mhsradiators.co.uk				

# 11. DECLARATION OF CONFORMITY

## DECLARATION OF CONFORMITY

We hereby declare for

FONDITAL S.p.A.  
via cerreto 40, 25079 Vobarno (BS) Italia

that

ELECTRICAL RADIATORS  
FOR HEATING  
Model  
eBlitz Wi-Fi

produced by FONDITAL S.p.A.

are manufactured according to Regulations:

- The Radio Equipment Regulations 2017 and amendments.
- Electrical Equipment (Safety) Regulations 2016 and amendments.
- Electromagnetic Compatibility Regulations 2016 and amendments.
- The Restriction of the Use of Certain Hazardous Substances in Electrical and Electronic Equipment Regulations 2012.

and in accordance with rules:

- BS EN 60335-1:2012+A11:2014 + A13:2017 +A1:2019 + A2:2019 + A14:2019.
- BS EN 60335-2-30:2009 + A11:2012 + A1:2020+A12:2020.
- BS EN 62233:2008
- BS EN 55014-1:2017
- BS EN 55014-2:2015
- ETSI EN 300 220-1:2017 V3.1.1
- ETSI EN 300 220-2 :2012 V3.1.1

FONDITAL S.p.A.  
Ing. Gianluigi Arici

Vobarno, 04/02/2021



MHS Radiators Limited, Unit 4 Genesis, Endeavour Drive, Basildon, SS14 3WF  
Tel: 0345 521 5666 Fax: 01268 888260

[orders@mhsradiators.co.uk](mailto:orders@mhsradiators.co.uk) [enquiries@mhsradiators.co.uk](mailto:enquiries@mhsradiators.co.uk) [mhsradiators.co.uk](http://mhsradiators.co.uk)

**SALES OFFICE - 0345 521 5666**  
**AFTERSALES - 01268 546775**

