

COB SHCVO C

COBALT Shower Range Cobalt Recessed Thermostatic Dual Control Shower Valve Chrome

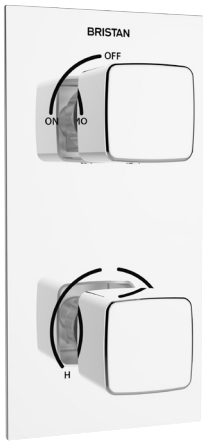

Features:

- 15mm inlet connections
- This shower valve has been designed to fit in any UK wall cavity and therefore only needs a 35mm deep cavity space
- Fitting depth including plasterboard and tiles is 60mm - 75mm
- Minimum cold water supply temperature is 4°C
- Maximum hot water supply temperature is 80°C

Product Certifications:



WRAS Cert. Number: 1910908
WRAS Expiry Date: 31/10/2024

For more products, visit our website:
<http://www.bristan.com>



Specification

Product Type:	Mixer Shower
Main Construction Material:	Brass
Connection Inlet:	15mm Compression
Connection Outlet:	15mm Compression
Number of Controls:	2
Flow Control Valve Type:	3/4" Quarter Turn Ceramic Disc Valve
Plumbing System:	Suitable for all plumbing systems
Minimum Dynamic Pressure:	0.2 Bar
Maximum Dynamic Pressure:	5.0 Bar
Maximum Static Pressure:	10
Maximum Hot Water Temperature: (°C)	80°C
Pre-set Outlet Temperature: (°C)	42°C
Isolation Included:	No
Check Valve Supplied:	Yes
Shower Kit:	Valve Only

Dimensions (measurements in mm)

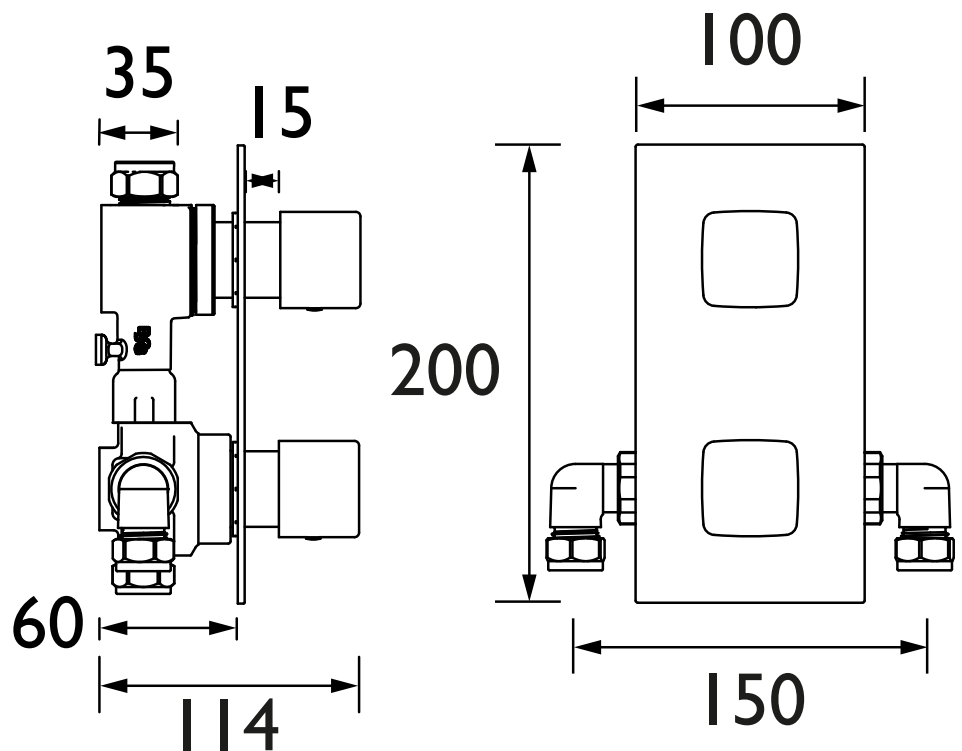

Flow Rates (l/min)

System Pressure (bar)	0.2	0.5	1	2	3	5
COB SHCVO C (mixed)	7.5	14.1	21	30.5	37.4	48.2

TECHNICAL
DATA
SHEET



BRISTAN

D6