

Fitting

- Point the spring clips upwards and fit the two longer arms into the ceiling hole.
- Push the unit upward until firmly in position, ensuring that the cable is not trapped.
- Push the lamp into the lampholder, and fit the lamp using the circlip.
- Replace fuse and switch on.

Fitting/replacing the bulbs

When changing a bulb, always switch off at the mains and allow the bulb to cool before handling. Dispose of used bulbs carefully. Use a soft cloth to handle bulbs, avoid directly touching the bulbs as this will shorten their life. Do not exceed the wattage stated or use a different shape bulb from that indicated on the fitting. Remove circlip by squeezing tabs together, to release the bulb. Twist the bulb to remove from the lampholder.

To refit, twist the bulb into the lampholder, fit into place. Fit the circlip into place by squeezing the tabs together and clipping into place.

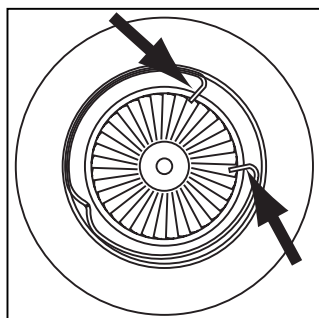

50W GU10
Mains Halogen

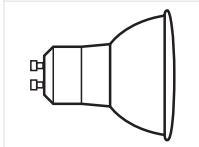

Instruction leaflet

Fixed Converse Recessed

52484, 52485



Care and Cleaning

We recommend cleaning with a soft dry cloth.

Do not use solvents or abrasive cleaners as these could damage the finish.

Recycling advice



Waste electrical products should not be disposed of with household waste. Please recycle where facilities exist. Check with your Local Authority or retailer for recycling advice.

Safety information

For your safety, always switch off the supply before changing lightbulbs, or cleaning.



saxby
lighting

Thank you for purchasing this light fitting.
Please read the instructions carefully before use to ensure safe and satisfactory operation of this product.
Please retain these instructions for future reference.

Warning



This product is Double Insulated and does not require connection to an Earth circuit.

Please read these instructions carefully before commencing any work.

This unit must be fitted by a competent and qualified electrician.

Install in accordance with IEE Wiring regulations and current Building Regulations.

To prevent electrocution switch off at mains supply before installing or maintaining this fitting. Ensure other persons cannot restore the electrical supply without your knowledge.

This light fitting should be connected to a fused circuit.

If replacing an existing fitting, make a careful note of the connections.

Always use the correct type and wattage bulb. Never

exceed the wattage stated.

When changing a bulb, always switch off at the mains and allow the old bulb to cool down before handling.

Dispose of used bulbs carefully and responsibly.

This product is suitable for dimming when used in conjunction with a dimmable lamp. Always check dimming capability of the intended lamps.

Waste electrical products should not be disposed of with household waste. Please recycle where facilities exist. Check with your local authority or retailer for recycling advice.

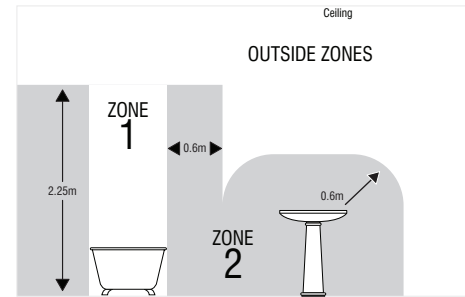

This product has no special protection against the ingress of moisture, and is rated as IP20.
This product is not suitable for use in Zones 0, 1 or 2, of a bathroom. See diagram.
The mains supply must be fitted to a 30mA RCD.

Installation

- Ensure the mains is disconnected. Remove the existing fitting and discard.
- Disconnect the wiring, and connect the chosen lampholder for mains voltage halogen GU10
- Fit the extended spring clips to the downlight and fit the downlight into the surround.
- Lift the downlight into position. Feed the cable through the centre of the downlight
- Wire as detailed below.

Wiring

This product is double insulated and must not be earthed. If there are any incoming earth cables, they must be joined together and well insulated with good quality insulation tape. This is to ensure earth continuity throughout your property.

Having correctly identified the wiring from your existing light fitting and connect to the connection block inside the product in the following way:

Specification

Voltage: 240V 50Hz a.c.
Lamp: All Models - 1 x Max. 50W GU10 Mains Halogen
IP rating: 20

Layout

- Plan the desired layout of these fittings carefully, ensuring the cables will reach the distances between the connector block and each light fitting.
- Avoid locating any cables in positions that would cause a hazard. Position cables and connector block away from areas where they may be at risk from being cut, trapped or damaged.
- Cables that are to be in walls must be protected using suitable conduit or plastic trunking.

Fixing sizes

- 65mm diameter cutout
- 150mm diameter cutout

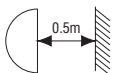

Spotlights give a concentrated beam of light and must not be positioned any closer than 0.5M (50cm) to the illuminated surface.

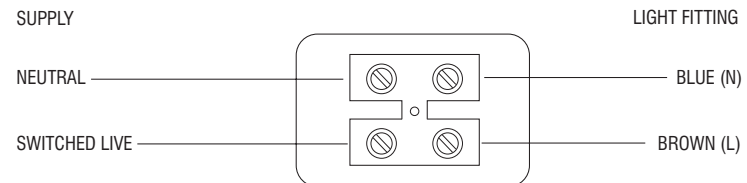

Check that...

- You have correctly identified the wires.
- The connections are tight.
- No loose strands have been left out of the connection block.