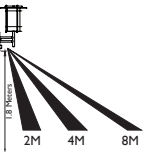
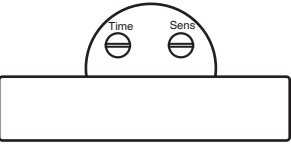

<p>Adjustable 1 - 8 metres</p> 	<p>Base of product</p> 
<p>Detection range can be adjusted by turning 'Sens' screw</p>	<p>Duration the bulb stays on is adjustable by turning 'Time' screw</p>

N.B: Unlike many PIR fittings these do not come on once first commissioned. They will only activate for the first time once the ambient light level drops below 10 Lux

Fitting/replacing bulb

When changing a bulb, always switch off at the mains and allow the bulb to cool before handling. Dispose of used bulbs carefully. Do not exceed the wattage stated or use a different shape bulb from that indicated on the fitting. To access the bulb, remove the screws on top of the

shade, and lift off the top. Set aside. Relocate the shade top over the screws and secure in place with the screws.

MAX. 60W E27 GLS

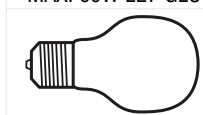

Care and Cleaning

Do not use solvents or abrasive cleaners as these could damage the finish. In normal circumstances, stainless steel is very resistant to corrosion. It does however require maintenance to preserve the high quality appearance. Wash the product with warm soapy water, removing all surface deposits. Rinse with clear water and with a soft cloth, wipe dry. In some cases, surface corrosion may arise after installation. This is normally caused by tiny iron particles left behind after the brushing process when finishing. Wash and dry as detailed above. Then with a soft cloth soaked with a protective oil, wipe all over. However if the product is subject to extreme environmental conditions such as marine locations,

industrial pollution and acid rain these maintenance procedures should be carried out around four times a year. For severe corrosion, non-abrasive cream cleaners or proprietary stainless steel cleaners should be used to remove the corrosion. Wash and dry as detailed above. Then with a soft cloth soaked with a protective oil, wipe all over. Shade - Remove and wash in warm water or just use a damp cloth. Do not use abrasive materials as these will damage the finish. **Do not clean the units with a pressure washer.**

Recycling advice

 Waste electrical products should not be disposed of with household waste. Please recycle where facilities exist. Check with your Local Authority or retailer for recycling advice.

Safety information

For your safety, always switch off the supply before changing lightbulbs, or cleaning.

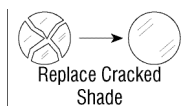

This bulb is protected by a shade. This part must be replaced immediately should the shade become cracked or damaged. This fitting must not be used without the shade in place.

Iss.3 03032016

Instruction leaflet

Inova PIR Wall

49945,49946



saxby
lighting

Thank you for purchasing this light fitting. Please read the instructions carefully before use to ensure safe and satisfactory operation of this product. Please retain these instructions for future reference.

Warning

This is a Class 1 product and must be earthed.

Please read these instructions carefully before commencing any work.

This unit must be fitted by a competent and qualified electrician.

Install in accordance with IEE Wiring regulations and current Building Regulations.

To prevent electrocution switch off at mains supply before installing or maintaining this fitting. Ensure other persons cannot restore the electrical supply without your knowledge. If you are in any doubt, please consult a qualified electrician.

This light fitting should be connected to a circuit with a 30mA RCD fitted.

If replacing an existing fitting, make a careful note of the connections.

Always use the correct type and wattage bulb. Never exceed the wattage stated.

When changing a bulb, always switch off at the mains and allow the old bulb to cool down before handling. Dispose of used bulbs carefully and responsibly.

Waste electrical products should not be disposed of with household waste. Please recycle where facilities exist. Check with your local authority or retailer for recycling advice.

This product is rated at IP44.

This product is not suitable for location in or near a marine environment.

The entire unit gets hot whilst on for a period of time.

Unlike many PIR fittings these do not come on once first commissioned. They will only activate for the first time once the ambient light level drops below 10 Lux

Specification

Voltage: 240V 50Hz a.c.
Lamp: 1 x Max 60W E27 (ES)
IP rating: 44

Layout

- Cables in walls must be protected using suitable conduit or plastic trunking.
- We recommend that you use H05RN-F specification cable (not supplied) which is an outdoor grade, rubber sheathed cable. The mains supply cable must have a minimum cross sectional area of 1.0mm
- This product has special protection against the ingress of moisture and is IP44 rated.

Installation

Existing fittings must be completely removed before installation of a new product. Before removing the existing fitting, **carefully note the position of each set of wires.**

- Remove mounting box (A) from product by removing dome nuts (C) and washers (D). Carefully pierce a small hole in the rubber gasket in the centre of the mounting box to allow the cable to pass through.
- Thread the cable through the hole, ensuring the drain hole is at the base of the mounting box.
- Fix the mounting box to the wall using the screws and plugs supplied (B). Ensure the wall is capable of holding the weight of the product. Take care to avoid damaging any concealed wiring and pipes. The correct fixings should be used for brick or cavity walls.
- Seal the screw fixings to maintain the IP rating of the fitting.

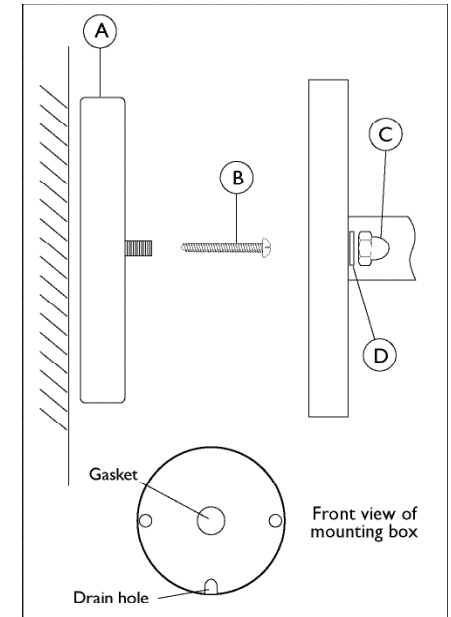

Wiring

Having correctly identified the wiring from your existing light fitting, pull the wire through the hole and connect to the connection block inside the product in the following way:

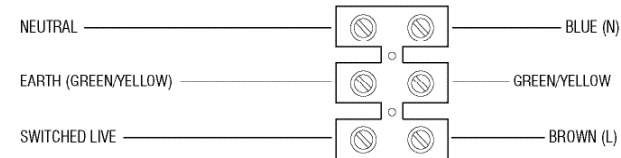

the connection block inside the product in the following way:

Check that...

- You have correctly identified the wires
- The connections are tight
- No loose strands have been left out of the connection block.

Commissioning

- Ensure that the cable is not snagged and seal to maintain the IP rating of the product.
- Fit the product back on to the mounting box and refit washers (D) and dome nuts (C), tighten dome nuts to

secure.

- Replace fuse or circuit breaker and switch on. Your light is now ready for use.

PIR Adjustment

- The unit must be installed in a vertical position, and fitted 1.8m above the ground.
- The PIR sensor can be adjusted, allowing the detection distance to be altered to suit the location. The detection angle is set at 110 degrees. The duration

that the lamp stays on can also be altered from 5 seconds - 5 minutes. Use a small screwdriver to adjust the 'TIME' and 'SENS' screws. When adjusting the sensitivity (detection distance) in daylight it will be necessary to cover the sensor to simulate night time.